

1844; 1845;
Fitted plug

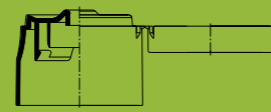

1846
Built-in seal

FLASCHE BOTTLE FLACON

Article no.	Capacity	Material	Weight	Neck finish	A	B	ø C
FPS 3984	50 ml	HDPE	10 g	REBHAN	44 mm	81 mm	12 mm
FPS 3985	100 ml	HDPE	14 g	REBHAN	50 mm	119 mm	12 mm
FPS 3986	200 ml	HDPE	20 g	REBHAN	63 mm	134 mm	17 mm

VERSCHLUSS CLOSURE CAPSULE

Article no.
1844
1845
1846



FPS 3984
+ 1844



FPS 3986
+ 1845



FPS 3986
+ 1846

LAOLA



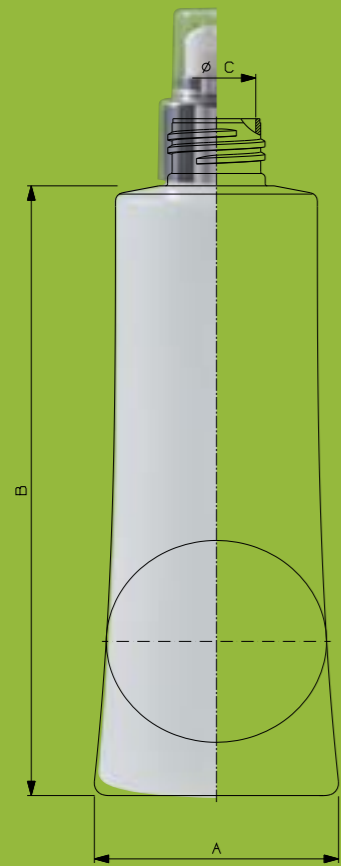

3995

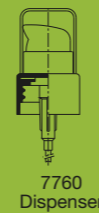
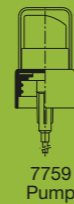
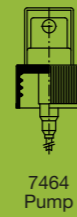
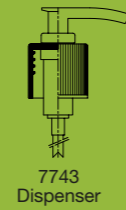

FLASCHE BOTTLE FLACON

VERSCHLUSS CLOSURE CAPSULE

Article no.	Capacity	Material	Weight	Neck finish	A	B	ø C	Article no.
FPS 3995	250 ml	HD-PE	26 g	24/410	60	148	19	7464, 7743, 7758, 7759, 7760, 7761, 7762

EMOTION



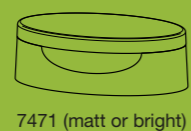
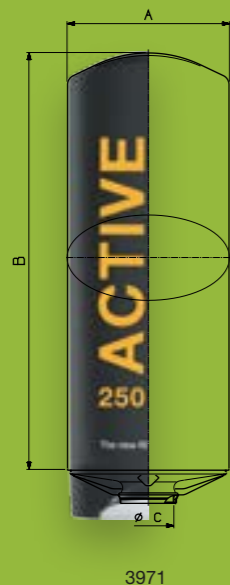

7471 (matt or bright)



7779
Built-in seal



7803

FLASCHE BOTTLE FLACON

Article no.	Capacity	Material	Weight	Neck finish	A	B	ø C
FPS 3971	250 ml	HDPE	22 g	REBHAN	66 mm	166 mm	21 mm

VERSCHLUSS CLOSURE CAPSULE

Article no.
7471, 7779, 7803

ACTIVE



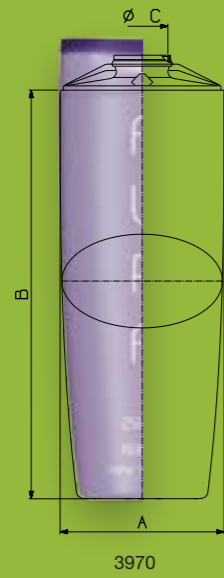

7471 (matt or bright)



7779
Built-in seal



7803

FLASCHE BOTTLE FLACON

Article no.	Capacity	Material	Weight	Neck finish	A	B	ø C
FPS 3970	250 ml	HDPE	22 g	REBHAN	66 mm	160 mm	21 mm

VERSCHLUSS CLOSURE CAPSULE

Article no.
7471, 7779, 7803

AURA



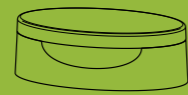
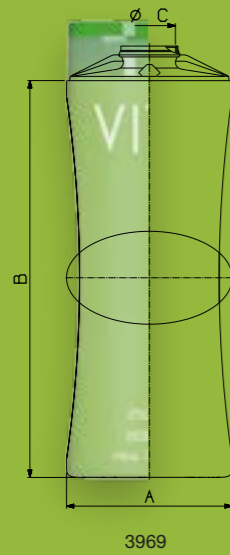

7471 (matt or bright)



7779
Built-in seal



7803

FLASCHE BOTTLE FLACON

Article no.	Capacity	Material	Weight	Neck finish	A	B	ø C
FPS 3969	250 ml	HDPE	22 g	REBHAN	66 mm	157 mm	21 mm

VERSCHLUSS CLOSURE CAPSULE

Article no.
7471, 7779, 7803

VITA



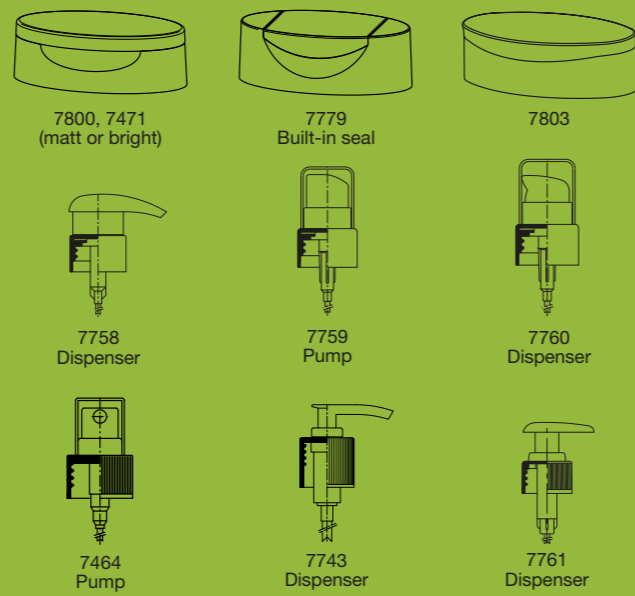
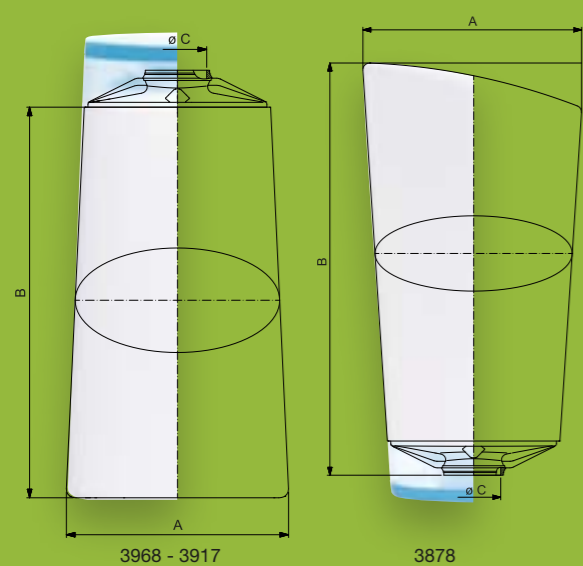

FLASCHE BOTTLE FLACON

Article no.	Capacity	Material	Weight	Neck finish	A	B	ø C
FPS 3968	100 ml	HDPE	14 g	REBHAN	60 mm	101 mm	15 mm
FPS 3897	200 ml	HDPE	22 g	REBHAN	76 mm	114 mm	21 mm
FPS 3877	250 ml	HDPE	25 g	REBHAN	78 mm	138 mm	21 mm
FPS 3915	300 ml	HDPE	28 g	REBHAN	80 mm	161 mm	21 mm
FPS 3915/2	300 ml	HDPE	28 g	24/410	80 mm	166 mm	19 mm
FPS 3917	400 ml	HDPE	35 g	REBHAN	83 mm	180 mm	21 mm

VERSCHLUSS CLOSURE CAPSULE

Article no.
7800
7471, 7779, 7803
7471, 7779, 7803
7471, 7779, 7803
7464, 7743, 7758, 7759, 7760, 7761, 7464, 7743, 7758, 7759, 7760, 7761
7471, 7779, 7803

TUBENFLASCHE TOTTLE FLACON TUBE

Article no.	Capacity	Material	Weight	Neck finish	A	B	ø C
FPS 3878	200 ml	HDPE	24 g	REBHAN	83 mm	144 mm	21 mm

VERSCHLUSS CLOSURE CAPSULE

Article no.
7471, 7779, 7803



ACCENT



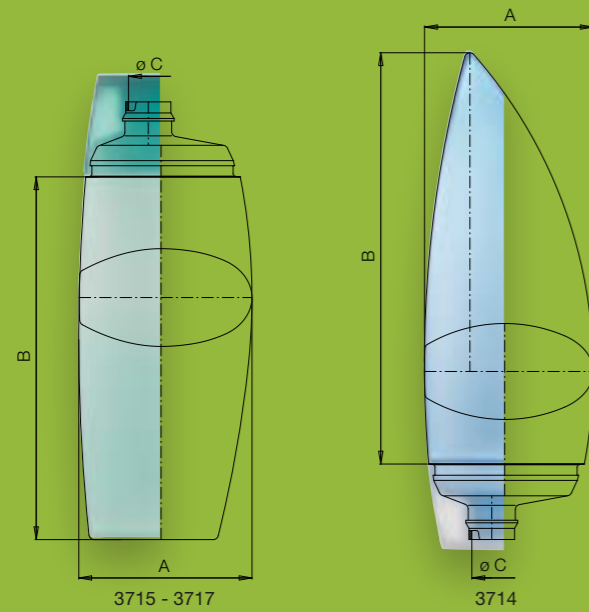

1806; 1810
Built-in seal

FLASCHE BOTTLE FLACON

Article no.	Capacity	Material	Weight	Neck finish	A	B	ø C
FPS 3715	200 ml	HDPE	20 g	REBHAN	66 mm	123 mm	16 mm
FPS 3716	250 ml	HDPE	22 g	REBHAN	68 mm	142 mm	16 mm
FPS 3717	300 ml	HDPE	24 g	REBHAN	69 mm	160 mm	16 mm

VERSCHLUSS CLOSURE CAPSULE

Article no.
1806
1806
1806

TUBENFLASCHE TOTTLE FLACON TUBE

Article no.	Capacity	Material	Weight	Neck finish	A	B	ø C
FPS 3714	200 ml	HD-/LDPE	20 g	REBHAN	66 mm	160 mm	16 mm
FPS 3714	200 ml	PP	20 g	REBHAN	66 mm	160 mm	16 mm

VERSCHLUSS CLOSURE CAPSULE

Article no.
1806
1806



FPS 3715

FPS 3716

FPS 3717

FPS 3714

AQUARIS



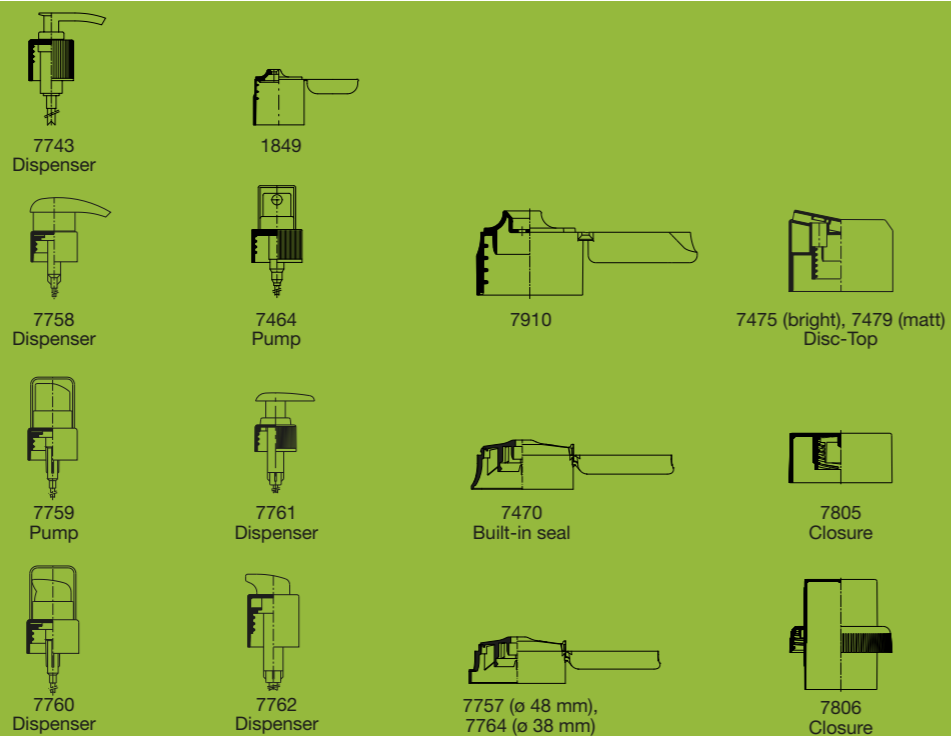
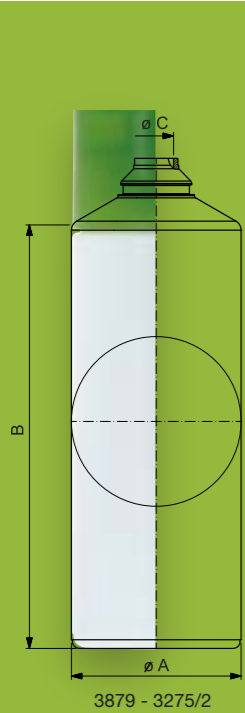

FLASCHE BOTTLE FLACON

VERSCHLUSS CLOSURE CAPSULE

Article no.	Capacity	Material	Weight	Neck finish	A	B	ø C	Article no.
FPS 3879	100 ml	HDPE	12 g	REBHAN	49 mm	64 mm	10 mm	7470, 7757, 7764
FPS 3879/1	100 ml	HDPE	12 g	REBHAN	49 mm	64 mm	17 mm	7475, 7479
FPS 387 9/2	100 ml	HDPE	14 g	24/410	49 mm	67 mm	19 mm	1849, 7464, 7743, 7758, 7759, 7760, 7761, 7762
FPS 3879/5	100 ml	HDPE	12 g	REBHAN	49 mm	65 mm	17 mm	7805
FPS 3880	150 ml	HDPE	16 g	REBHAN	49 mm	95 mm	10 mm	7470, 7757, 7764
FPS 3880/1	150 ml	HDPE	16 g	REBHAN	49 mm	95 mm	17 mm	7475, 7479
FPS 3880/2	150 ml	HDPE	18 g	24/410	49 mm	97 mm	19 mm	1849, 7464, 7743, 7758, 7759, 7760, 7761, 7762
FPS 3880/5	150 ml	HDPE	16 g	REBHAN	49 mm	95 mm	17 mm	7805
FPS 3881	200 ml	HDPE	20 g	REBHAN	49 mm	123 mm	10 mm	7470, 7757, 7764
FPS 3881/1	200 ml	HDPE	20 g	REBHAN	49 mm	123 mm	17 mm	7475, 7479
FPS 3881/2	200 ml	HDPE	22 g	24/410	49 mm	125 mm	19 mm	1849, 7464, 7743, 7758, 7759, 7760, 7761, 7762
FPS 3881/5	200 ml	HDPE	20 g	REBHAN	49 mm	124 mm	17 mm	7805
FPS 3882	250 ml	HDPE	24 g	REBHAN	49 mm	152 mm	10 mm	7470, 7757, 7764
FPS 3882/1	250 ml	HDPE	24 g	REBHAN	49 mm	152 mm	17 mm	7475, 7479
FPS 3882/2	250 ml	HDPE	26 g	24/410	49 mm	154 mm	19 mm	1849, 7464, 7743, 7758, 7759, 7760, 7761, 7762
FPS 3882/3	250 ml	HDPE	29 g	REBHAN	49 mm	165 mm	37 mm	7806
FPS 3882/5	250 ml	HDPE	24 g	REBHAN	49 mm	154 mm	17 mm	7805
FPS 3275/2	500 ml	HDPE	32 g	REBHAN	61 mm	195 mm	17 mm	7475, 7479
FPS 3275/3	500 ml	HDPE	50 g	28/410	60,5 mm	198 mm	25 mm	7910



FPS 3879 + 7764



FPS 3880/2 + 7759



FPS 3880/5



FPS 3881 + 7470



FPS 3882/2 + 7762



FPS 3275/2 + 7475

VARIO



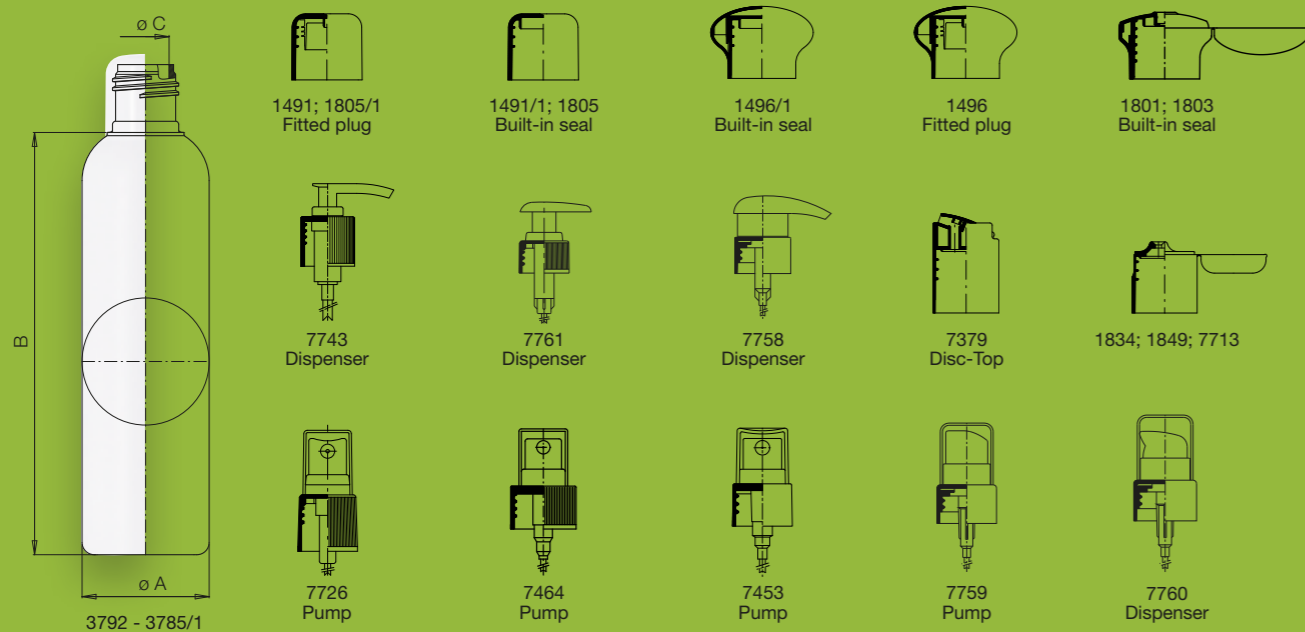

FLASCHE BOTTLE FLACON

VERSCHLUSS CLOSURE CAPSULE

Article no.	Capacity	Material	Weight	Neck finish	A	B	ø C	Article no.
FPS 3792	50 ml	HDPE, PP	10 g	20/410	31 mm	93 mm	14 mm	7453
FPS 3792/1	50 ml	HDPE, PP	10 g	20/415	31 mm	93 mm	14 mm	1805, 1805/1, 1803, 7726
FPS 3787	100 ml	HDPE, PP	16 g	24/410	37 mm	122 mm	19 mm	1849, 7464, 7743, 7758, 7759, 7760, 7761
FPS 3787/1	100 ml	HDPE, PP	16 g	24/415	37 mm	122 mm	17 mm	1491, 1491/1, 1496, 1496/1, 1801, 1834, 7379, 7713
FPS 3793	150 ml	HDPE, PP	19 g	24/410	42 mm	139 mm	19 mm	1849, 7464, 7743, 7758, 7759, 7760, 7761
FPS 3793/1	150 ml	HDPE, PP	19 g	24/415	42 mm	139 mm	17 mm	1491, 1491/1, 1496, 1496/1, 1801, 1834, 7379, 7713
FPS 3786	200 ml	HDPE, PP	22 g	24/410	46 mm	151 mm	19 mm	1849, 7464, 7743, 7758, 7759, 7760, 7761
FPS 3786/1	200 ml	HDPE, PP	22 g	24/415	46 mm	151 mm	17 mm	1491, 1491/1, 1496, 1496/1, 1801, 1834, 7379, 7713
FPS 3794	250 ml	HDPE, PP	24 g	24/410	49 mm	163 mm	19 mm	1849, 7464, 7743, 7758, 7759, 7760, 7761
FPS 3794/1	250 ml	HDPE, PP	24 g	24/415	49 mm	163 mm	17 mm	1491, 1491/1, 1496, 1496/1, 1801, 1834, 7379, 7713
FPS 3785	300 ml	HDPE, PP	26 g	24/410	52 mm	172 mm	19 mm	1849, 7464, 7743, 7758, 7759, 7760, 7761
FPS 3785/1	300 ml	HDPE, PP	26 g	24/415	52 mm	172 mm	17 mm	1491, 1491/1, 1496, 1496/1, 1801, 1834, 7379, 7713



ALLROUND



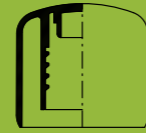
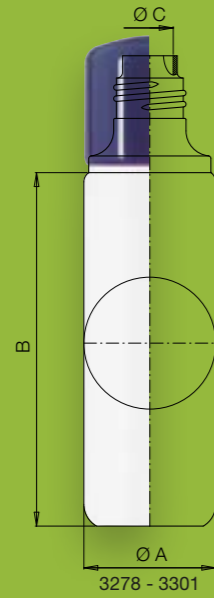

1373; 1376; 1370;
1375; 1393; 1394;
1395; 1396; 1398
Built-in seal

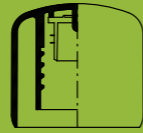

1373/1; 1376/1;
1370/1; 1375/1;
1393/1; 1394/1;
1395/1; 1396/1;
1397/1; 1398/1
Fitted plug

FLASCHE BOTTLE FLACON

VERSCHLUSS CLOSURE CAPSULE

Article no.	Capacity	Material	Weight	Neck finish	A	B	ø C	Article no.
FPS 3278	25 ml	HDPE	6 g	REBHAN	27 mm	52 mm	13 mm	1373, 1373/1
FPS 3279	30 ml	HDPE	7 g	REBHAN	27 mm	63 mm	13 mm	1373, 1373/1
FPS 3280	40 ml	HDPE	5 g	REBHAN	29 mm	72 mm	13 mm	1376, 1376/1
FPS 3293	50 ml	HDPE	6 g	REBHAN	30 mm	83 mm	13 mm	1376, 1376/1
FPS 3294	75 ml	HDPE	9 g	REBHAN	34 mm	95 mm	13 mm	1370, 1370/1
FPS 3295	100 ml	HDPE	15 g	REBHAN	38 mm	109 mm	13 mm	1375, 1375/1
FPS 3296	125 ml	HDPE	18 g	REBHAN	41 mm	109 mm	13 mm	1393, 1393/1
FPS 3297	150 ml	HDPE	20 g	REBHAN	44 mm	118 mm	13 mm	1394, 1394/1
FPS 3298	200 ml	HDPE	23 g	REBHAN	47 mm	127 mm	17 mm	1395, 1395/1
FPS 3299	250 ml	HDPE	25 g	REBHAN	51 mm	136 mm	17 mm	1396, 1396/1
FPS 3300	300 ml	HDPE	27 g	REBHAN	54 mm	142 mm	17 mm	1397/1
FPS 3301	500 ml	HDPE	40 g	REBHAN	65 mm	160 mm	17 mm	1398, 1398/1



FPS 3278



FPS 3295



FPS 3298



FPS 3300

OLYMP



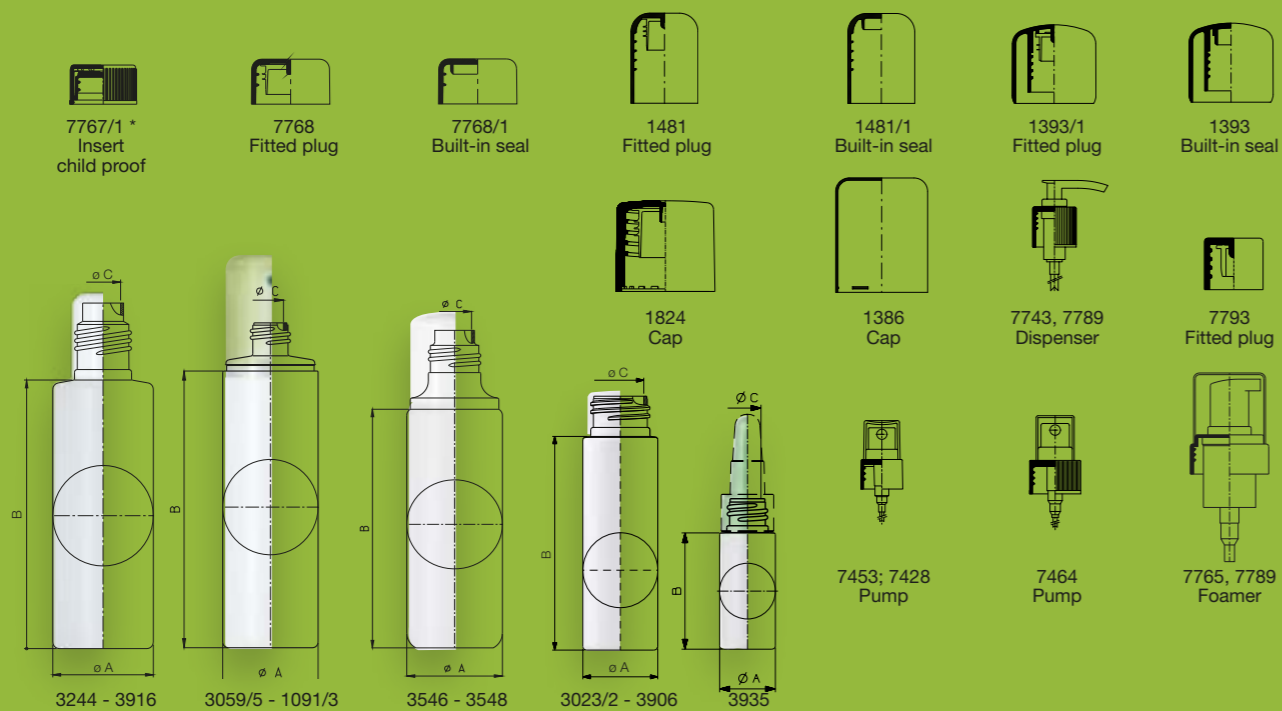

* Die Funktion der Kindersicherung bezieht sich ausschließlich auf die Gesamtverpackung. Die Inverkehrbringung einer kindersicheren Verpackung erfordert grundsätzlich eine entsprechende Prüfung und Zertifizierung.
 * The function of the child resistant lock always affects the overall packaging not just the cap. To bring child resistant packaging into the market, strictly requires appropriate testing and certification.
 * La fonction de sécurité enfant concerne exclusivement l'emballage complet. Un contrôle et une certification appropriés sont nécessaires avant toute mise en circulation d'un emballage avec sécurité enfant.

FLASCHE BOTTLE FLACON

VERSCHLUSS CLOSURE CAPSULE

Article no.	Capacity	Material	Weight	Neck finish	A	B	ø C	Article no.
FPS 3935	5 ml	PE	2 g	REBHAN	17 mm	35 mm	8 mm	Madison Cosmetics
FPS 3023/2	10 ml	PP	2,5 g	REBHAN	19 mm	57 mm	7 mm	7793
FPS 3906	50 ml	HDPE	7 g	24/410	30 mm	86 mm	19 mm	7464, 7743, 7760, 7762, 7768, 7768/1
FPS 3906/2	50 ml	HDPE	7 g	24/415	30 mm	85 mm	17 mm	1824/2
FPS 3934	50 ml	PETG	9 g	REBHAN	34 mm	76 mm	25 mm	7789
FPS 3244	100 ml	HDPE	16 g	REBHAN	38 mm	103 mm	13 mm	1481, 1481/1
FPS 3059/5	100 ml	HDPE	13 g	GL 20	41 mm	90 mm	14 mm	1386, 7453
FPS 3546	100 ml	HDPE	15 g	REBHAN	45 mm	71 mm	13 mm	1393, 1393/1
FPS 3547	125 ml	HDPE	18 g	REBHAN	45 mm	89 mm	13 mm	1393, 1393/1
FPS 1091/3	150 ml	HDPE	15 g	GL 18	42 mm	122 mm	12 mm	1386, 7428
FPS 3904	150 ml	PET	27 g	REBHAN	48 mm	112 mm	34 mm	7765
FPS 3548	200 ml	HDPE	23 g	REBHAN	45 mm	139 mm	13 mm	1393, 1393/1
FPS 3916	1000 ml	HDPE	75 g	28/410	78 mm	253,5 mm	21 mm	7767/1 *, 7910



ROUNDS



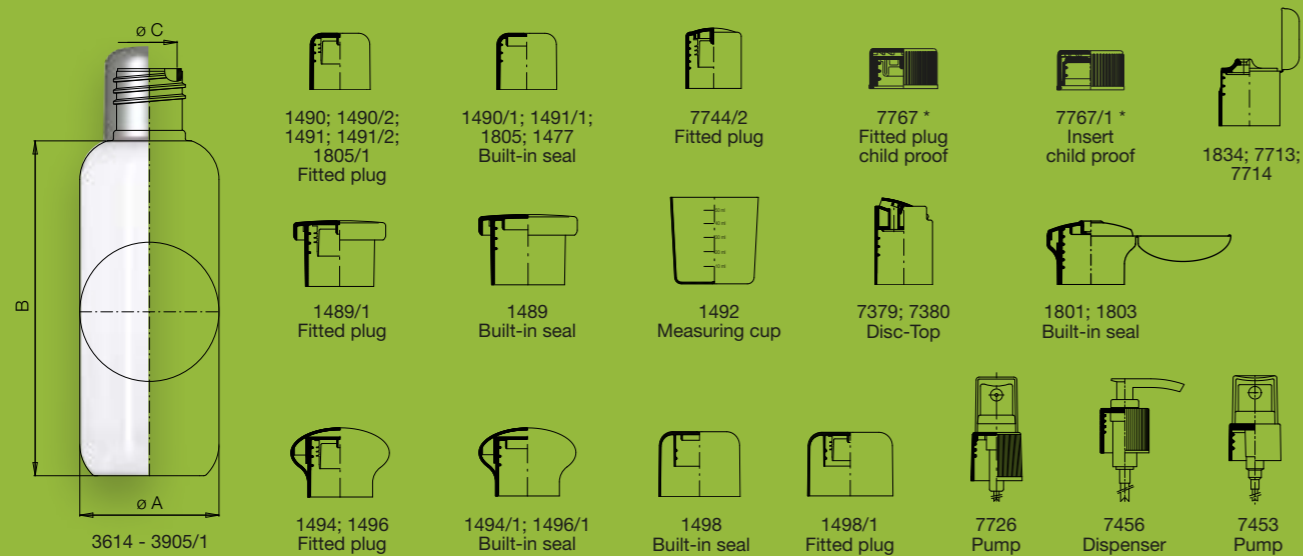

* Die Funktion der Kindersicherung bezieht sich ausschließlich auf die Gesamtverpackung. Die Inverkehrbringung einer kindersicheren Verpackung erfordert grundsätzlich eine entsprechende Prüfung und Zertifizierung.
 * The function of the child resistant lock always affects the overall packaging not just the cap. To bring child resistant packaging into the market, strictly requires appropriate testing and certification.
 * La fonction de sécurité enfant concerne exclusivement l'emballage complet. Un contrôle et une certification appropriés sont nécessaires avant toute mise en circulation d'un emballage avec sécurité enfant.

FLASCHE BOTTLE FLACON

VERSCHLUSS CLOSURE CAPSULE

Article no.	Capacity	Material	Weight	Neck finish	A	B	ø C	Article no.
FPS 3614	20 ml	PET	4 g	REBHAN	25 mm	49 mm	7 mm	1477
FPS 3726	50 ml	PET	11 g	20/410	36 mm	67 mm	14 mm	7453
FPS 3726/1	50 ml	PET	11 g	20/415	36 mm	67 mm	14 mm	1803, 1805/1, 1805, 7726
FPS 3859	75 ml	PET	13 g	24/415	38,5 mm	77 mm	17 mm	1491, 1491/1, 1491/2 (PET), 1496, 1496/1, 1801, 1834, 7379, 7713
FPS 3586	100 ml	PET	13 g	24/415	41 mm	87 mm	17 mm	1491, 1491/1, 1491/2 (PET), 1496, 1496/1, 1801, 1834, 7379, 7713
FPS 3724	100 ml	PET	14 g	20/410	41 mm	93 mm	14 mm	7453
FPS 3724/1	100 ml	PET	14 g	20/415	41 mm	93 mm	14 mm	1803, 1805/1, 1805, 7726
FPS 3587	125 ml	PET	15 g	24/415	44 mm	96 mm	17 mm	1491, 1491/1, 1491/2 (PET), 1496, 1496/1, 1801, 1834, 7379, 7713
FPS 3588	150 ml	PET	17 g	24/415	46 mm	105 mm	17 mm	1491, 1491/1, 1491/2 (PET), 1496, 1496/1, 1801, 1834, 7379, 7713
FPS 3589	200 ml	PET	19 g	28/415	50 mm	115 mm	21 mm	1489, 1489/1, 1490, 1490/1, 1490/2 (PET), 1492, 1494, 1494/1, 7380, 7456, 7714, 7744/2 (PET)
FPS 3590	250 ml	PET	24 g	28/415	53 mm	128 mm	21 mm	1489, 1489/1, 1490, 1490/1, 1490/2 (PET), 1492, 1494, 1494/1, 1498, 1498/1, 7380, 7456, 7714, 7744/2 (PET)
FPS 3591	300 ml	PET	27 g	28/415	56 mm	138 mm	21 mm	1489, 1489/1, 1490, 1490/1, 1490/2 (PET), 1492, 1494, 1494/1, 7380, 7456, 7714, 7744/2 (PET)
FPS 3592	400 ml	PET	30 g	28/415	61 mm	154 mm	21 mm	1489, 1489/1, 1490, 1490/1, 1490/2 (PET), 1492, 1494, 1494/1, 7380, 7456, 7714, 7744/2 (PET)
FPS 3592/1	400 ml	PET	30 g	28/415	61 mm	154 mm	21 mm	1498, 1498/1
FPS 3593	500 ml	PET	35 g	28/415	66 mm	165 mm	21 mm	1489, 1489/1, 1490, 1490/1, 1490/2 (PET), 1492, 1494, 1494/1, 7380, 7456, 7714, 7744/2 (PET)
FPS 3593/1	500 ml	PET	35 g	28/415	66 mm	165 mm	21 mm	1498, 1498/1
FPS 3905	1000 ml	PET	45 g	28/415	83 mm	217 mm	21 mm	1489, 1489/1, 1490, 1490/1, 1490/2 (PET), 1492, 1494, 1494/1, 7380, 7456, 7714, 7744/2 (PET)
FPS 3905/1	1000 ml	PET	45 g	28/410	83 mm	217 mm	22 mm	7767 *, 7767/1 *



FPS 3589 + 7380 FPS 3589 + 1494 FPS 3589 + 7456 FPS 3588 + 1834 FPS 3589 + 1489 + 1492 FPS 3724/1 + 1803 FPS 3724/1 + 7726 FPS 3589 + 1490 FPS 3589 + 7714

OPTIMA



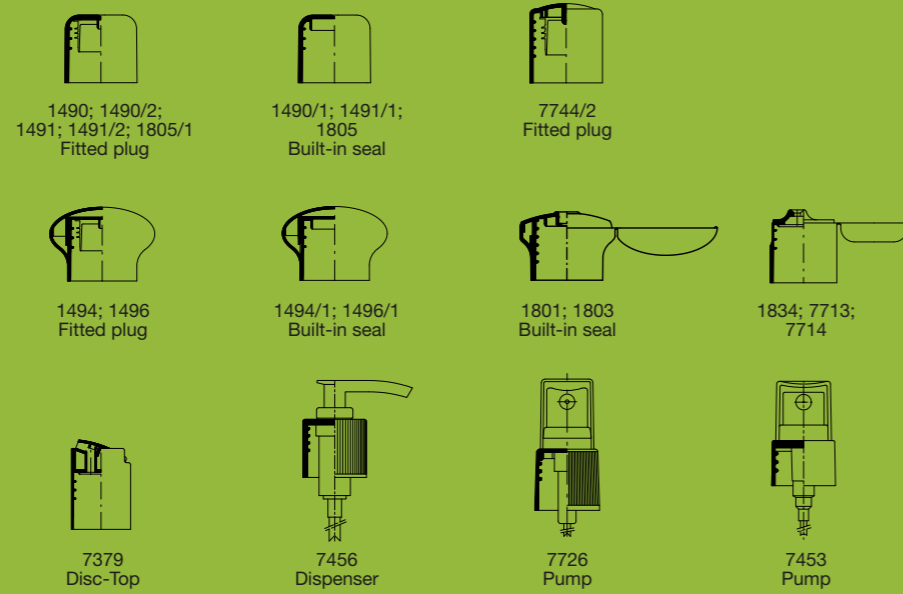
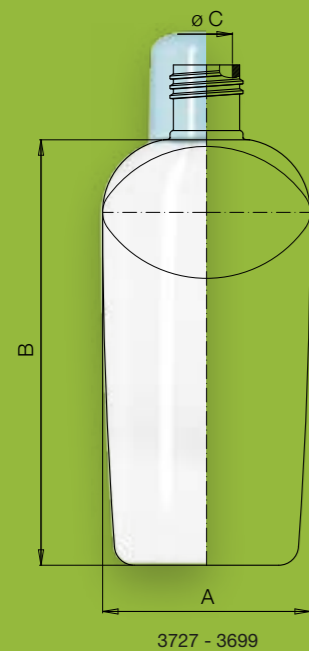

3727 - 3699

FLASCHE BOTTLE FLACON

VERSCHLUSS CLOSURE CAPSULE

Article no.	Capacity	Material	Weight	Neck finish	A	B	ø C	Article no.
FPS 3727	50 ml	PET	11 g	20/410	41 mm	84 mm	14 mm	7453
FPS 3727/1	50 ml	PET	11 g	20/415	41 mm	84 mm	14 mm	1803, 1805, 1805/1, 7726
FPS 3725	100 ml	PET	14 g	20/410	50 mm	103 mm	14 mm	7453
FPS 3725/1	100 ml	PET	14 g	20/415	50 mm	103 mm	14 mm	1803, 1805, 1805/1, 7726
FPS 3696	150 ml	PET	18 g	20/415	58 mm	118 mm	14 mm	1803, 1805, 1805/1, 7726
FPS 3691	200 ml	PET	22 g	24/415	63 mm	129 mm	17 mm	1491, 1491/1, 1491/2 (PET), 1496, 1496/1, 1801, 1834, 7379, 7713
FPS 3692	250 ml	PET	22 g	24/415	68 mm	138 mm	17 mm	1491, 1491/1, 1491/2 (PET), 1496, 1496/1, 1801, 1834, 7379, 7713
FPS 3693	300 ml	PET	24 g	24/415	72 mm	146 mm	17 mm	1491, 1491/1, 1491/2 (PET), 1496, 1496/1, 1801, 1834, 7379, 7713
FPS 3699	500 ml	PET	35 g	28/415	84 mm	172 mm	17 mm	1490, 1490/1, 1490/2 (PET), 1494, 1494/1, 7380, 7456, 7714, 7744/2 (PET)



CLASSIC



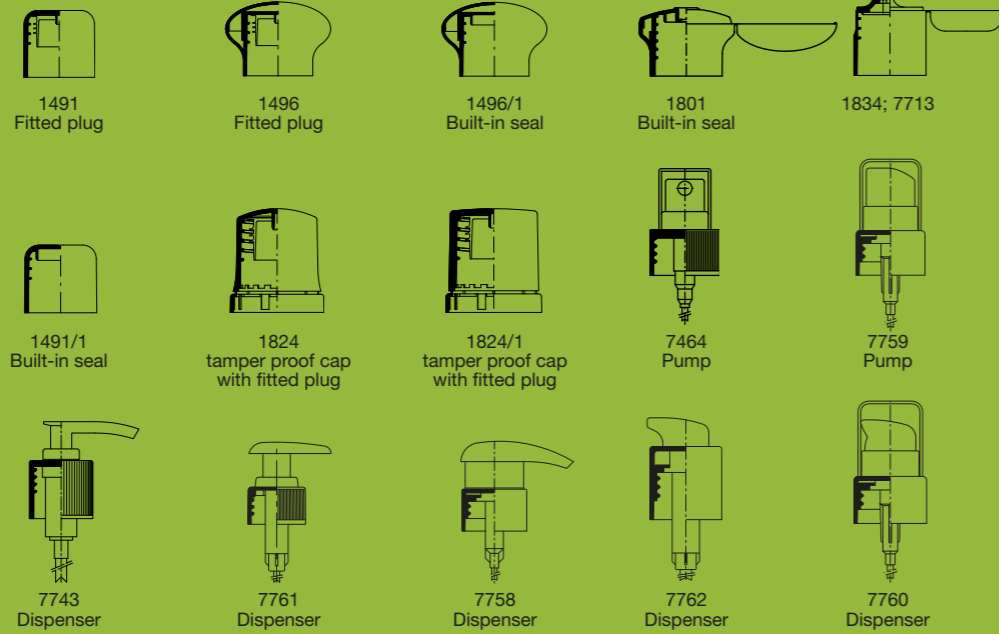
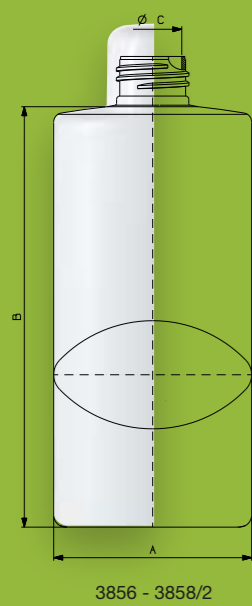

FLASCHE BOTTLE FLACON

VERSCHLUSS CLOSURE CAPSULE

Article no.	Capacity	Material	Weight	Neck finish	A	B	ø C	Article no.
FPS 3856	150 ml	HDPE	17 g	24/415	59 mm	128 mm	17 mm	1491, 1491/1, 1496, 1496/1, 1801, 1834, 7713
FPS 3856/1	150 ml	HDPE	17 g	24/410	59 mm	128 mm	19 mm	7464, 7743, 7758, 7759, 7760, 7761, 7762
FPS 3856/2	150 ml	HDPE	17 g	REBHAN	59 mm	128 mm	17 mm	1824, 1824/1 Originalitätsverschluss Tamper proof cap Capsule inviolable
FPS 3857	200 ml	HDPE	20 g	24/415	65 mm	138 mm	17 mm	1491, 1491/1, 1496, 1496/1, 1801, 1834, 7713
FPS 3857/1	200 ml	HDPE	20 g	24/410	65 mm	138 mm	19 mm	7464, 7743, 7758, 7759, 7760, 7761, 7762
FPS 3857/2	200 ml	HDPE	20 g	REBHAN	65 mm	138 mm	17 mm	1824, 1824/1 Originalitätsverschluss Tamper proof cap Capsule inviolable
FPS 3858	250 ml	HDPE	23 g	24/415	69 mm	149 mm	17 mm	1491, 1491/1, 1496, 1496/1, 1801, 1834, 7713
FPS 3858/1	250 ml	HDPE	23 g	24/410	69 mm	149 mm	19 mm	7464, 7743, 7758, 7759, 7760, 7761, 7762
FPS 3858/2	250 ml	HDPE	23 g	REBHAN	69 mm	149 mm	17 mm	1824, 1824/1 Originalitätsverschluss Tamper proof cap Capsule inviolable



FPS 3856 + 1491 FPS 3857 + 7713 FPS 3857 + 1496 FPS 3857/1 + 7464 FPS 3858/1 + 7743

SELECT



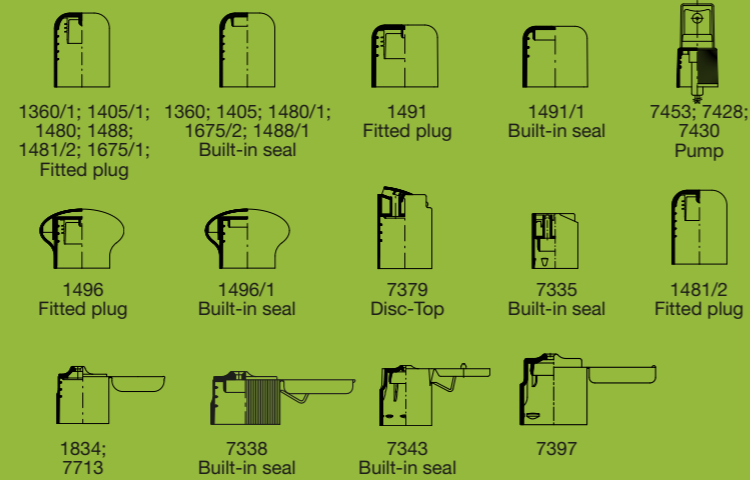
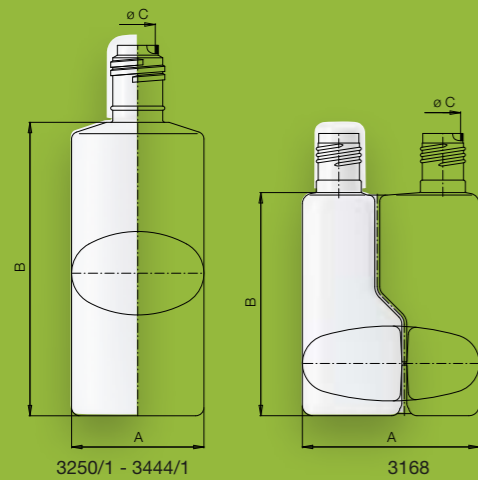

FLASCHE BOTTLE FLACON

VERSCHLUSS CLOSURE CAPSULE

Article no.	Capacity	Material	Weight	Neck finish	A	B	ø C	Article no.
FPS 3250/1	40 ml	HDPE	6 g	REBHAN	35 mm	74 mm	13 mm	7338
FPS 3250/2	40 ml	HDPE	6 g	GL 18	35 mm	74 mm	10 mm	7428
FPS 3190/1	50 ml	HDPE	7 g	GL 18	37 mm	87 mm	12 mm	7428
FPS 3190/2	50 ml	HDPE	7 g	REBHAN	37 mm	87 mm	13 mm	1480, 1480/1
FPS 3479	75 ml	HDPE	10 g	REBHAN	42 mm	99 mm	13 mm	1480, 1480/1
FPS 3191/2	100 ml	HDPE	13 g	GL 20	47 mm	111 mm	14 mm	7453
FPS 3191/3	100 ml	HDPE	13 g	REBHAN	47 mm	111 mm	17 mm	1481/2
FPS 3191/7	100 ml	HDPE	13 g	REBHAN	47 mm	111 mm	17 mm	1834, 7713
FPS 3192/1	125 ml	HDPE	15 g	REBHAN	51 mm	117 mm	17 mm	1675/1, 1675/2
FPS 3192/2	125 ml	HDPE	18 g	GL 18	51 mm	117 mm	12 mm	7428
FPS 3219/1	150 ml	HDPE	17 g	REBHAN	53 mm	127 mm	22 mm	7335
FPS 3219/2	150 ml	HDPE	17 g	GL 20	53 mm	127 mm	14 mm	7453
FPS 3192/5	125 ml	HDPE	18 g	24/415	51 mm	117 mm	12 mm	1397, 1491, 1491/1, 1834, 7713
FPS 3219/3	150 ml	HDPE	17 g	REBHAN	53 mm	127 mm	17 mm	1360, 1360/1
FPS 3219/7	150 ml	HDPE	17 g	REBHAN	53 mm	127 mm	17 mm	1834, 7713
FPS 3193	200 ml	HDPE	20 g	REBHAN	59 mm	133 mm	20 mm	7397
FPS 3193/1	200 ml	HDPE	20 g	REBHAN	59 mm	133 mm	17 mm	1360, 1360/1
FPS 3193/2	200 ml	HDPE	20 g	REBHAN	59 mm	133 mm	22 mm	7335
FPS 3193/9	200 ml	HDPE	20 g	24/415	59 mm	133 mm	17 mm	1491, 1491/1, 1496, 1496/1, 1834, 7379, 7713
FPS 3194	250 ml	HDPE	25 g	REBHAN	64 mm	141 mm	20 mm	7397
FPS 3194/1	250 ml	HDPE	25 g	REBHAN	64 mm	141 mm	17 mm	1360, 1360/1
FPS 3194/2	250 ml	HDPE	25 g	REBHAN	64 mm	141 mm	22 mm	7335
FPS 3194/6	250 ml	HDPE	25 g	24/415	64 mm	141 mm	17 mm	1491, 1491/1, 1496, 1496/1, 1834, 7379, 7713
FPS 3347/1	250 ml	HDPE	30 g	22/415	64 mm	147 mm	16 mm	7430
FPS 3830	250 ml	HDPE	28 g	REBHAN	64 mm	141 mm	17 mm	1360, 1360/1 Flasche mit tastbarem Gefahrenhinweis
FPS 3195	300 ml	HDPE	26 g	REBHAN	68 mm	149 mm	20 mm	7397
FPS 3195/1	300 ml	HDPE	26 g	REBHAN	68 mm	149 mm	17 mm	1360, 1360/1
FPS 3195/2	300 ml	HDPE	26 g	REBHAN	68 mm	149 mm	22 mm	7335
FPS 3196/8	500 ml	HDPE	40 g	REBHAN	81 mm	175 mm	21 mm	1488, 1488/1
FPS 3444	1000 ml	HDPE	55 g	REBHAN	100 mm	220 mm	20 mm	1405
FPS 3444/1	1000 ml	HDPE	55 g	REBHAN	100 mm	220 mm	20 mm	1405/1
FPS 3168	2x100 ml	HDPE	34 g	REBHAN	85 mm	107 mm	17 mm	1481/2



FPS 3191/3



FPS 3193/9 + 7379



FPS 3194/1 + 1360



FPS 3168 + 1481/2

OVAL



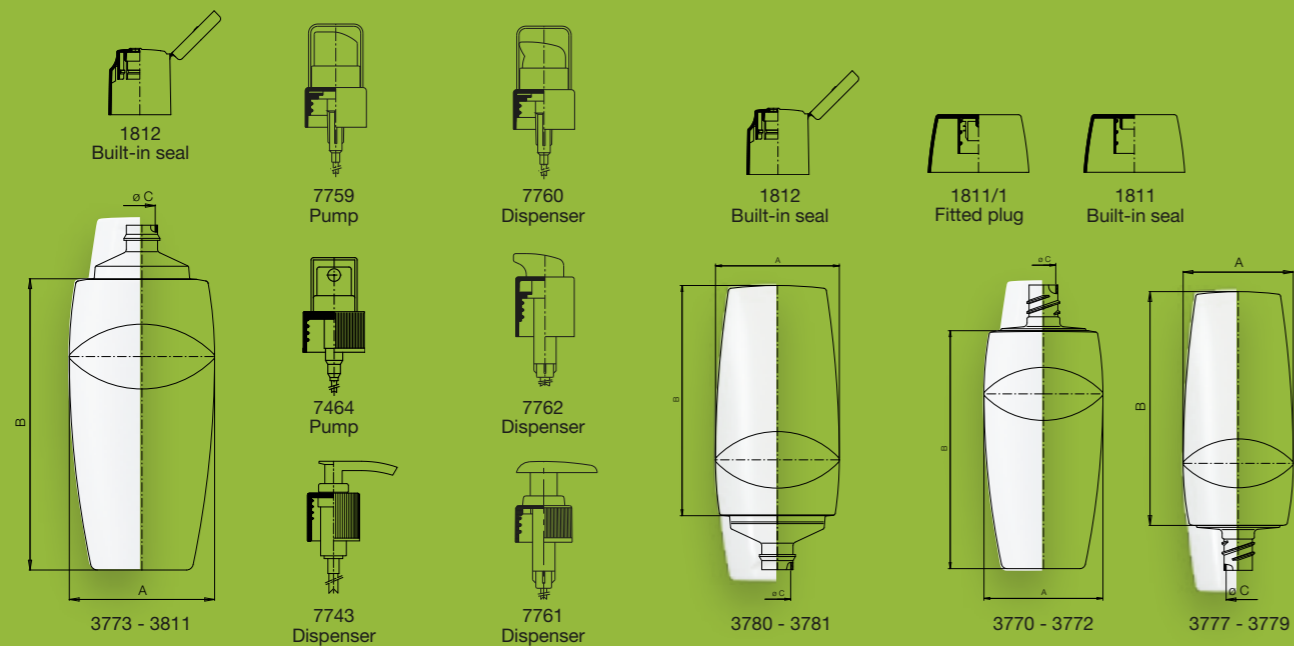

FLASCHE BOTTLE FLACON

VERSCHLUSS CLOSURE CAPSULE

Article no.	Capacity	Material	Weight	Neck finish	A	B	ø C	Article no.
FPS 3770	50 ml	HDPE	10 g	REBHAN	51 mm	82 mm	12 mm	1811, 1811/1
FPS 3771	75 ml	HDPE	12 g	REBHAN	55 mm	110 mm	12 mm	1811, 1811/1
FPS 3772	100 ml	HDPE	14 g	REBHAN	60 mm	120 mm	12 mm	1811, 1811/1
FPS 3773	150 ml	HDPE	17 g	REBHAN	68 mm	136 mm	14 mm	1812
FPS 3773/1	150 ml	HDPE	17 g	24/410	68 mm	136 mm	18 mm	7464, 7743, 7759, 7760, 7761, 7762
FPS 3774	200 ml	HDPE	21 g	REBHAN	74 mm	148 mm	14 mm	1812
FPS 3774/2	200 ml	HDPE	21 g	24/410	74 mm	148 mm	18 mm	7464, 7743, 7759, 7760, 7761, 7762
FPS 3775	250 ml	HDPE	25 g	REBHAN	79 mm	158 mm	14 mm	1812
FPS 3775/1	250 ml	HDPE	25 g	24/410	79 mm	158 mm	18 mm	7464, 7743, 7759, 7760, 7761, 7762
FPS 3776	300 ml	HDPE	27 g	REBHAN	84 mm	168 mm	14 mm	1812
FPS 3776/1	300 ml	HDPE	27 g	24/410	84 mm	168 mm	18 mm	7464, 7743, 7759, 7760, 7761, 7762
FPS 3811	400 ml	HDPE	32 g	REBHAN	91 mm	184 mm	14 mm	1812

TUBENFLASCHE TOTTLE FLACON TUBE

VERSCHLUSS CLOSURE CAPSULE

Article no.	Capacity	Material	Weight	Neck finish	A	B	ø C	Article no.
FPS 3777	30 ml	HD-/LDPE	7 g	REBHAN	48 mm	73 mm	12 mm	1811, 1811/1
FPS 3778	50 ml	HD-/LDPE	10 g	REBHAN	51 mm	101 mm	12 mm	1811, 1811/1
FPS 3779	75 ml	HD-/LDPE	12 g	REBHAN	57 mm	120 mm	12 mm	1811, 1811/1
FPS 3780	100 ml	HD-/LDPE	16 g	REBHAN	63 mm	117 mm	14 mm	1812
FPS 3781	150 ml	HD-/LDPE	20 g	REBHAN	70 mm	148 mm	14 mm	1812



SCALA

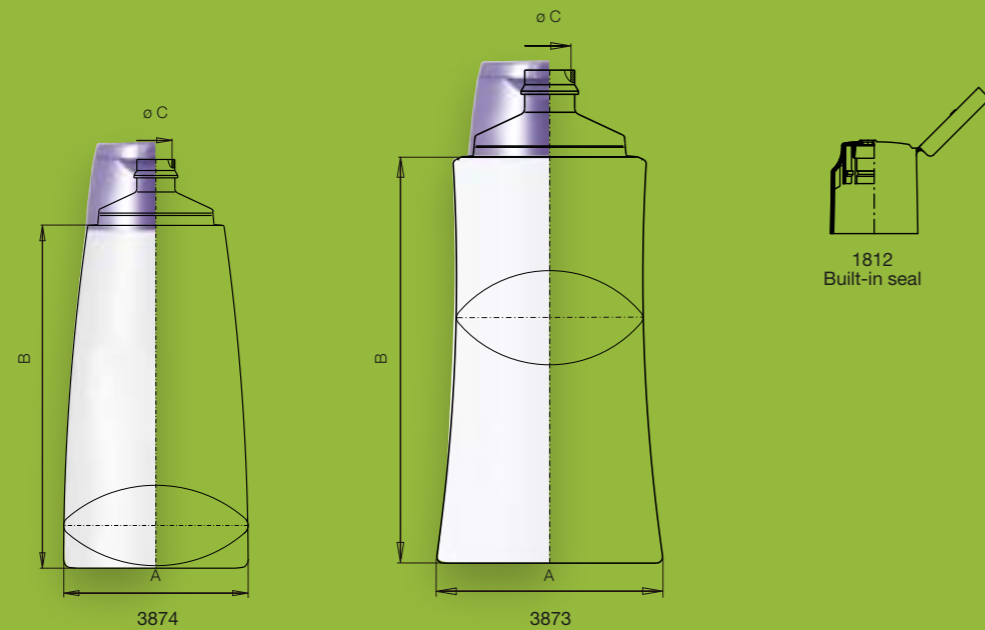

FLASCHE BOTTLE FLACON

VERSCHLUSS CLOSURE CAPSULE

Article no.	Capacity	Material	Weight	Neck finish	A	B	ø C	Article no.
FPS 3874	200 ml	HDPE	24 g	REBHAN	77 mm	114 mm	14 mm	1812
FPS 3873	200 ml	HDPE	24 g	REBHAN	79 mm	142 mm	14 mm	1812

DELTA & STELLA



STANDARDS

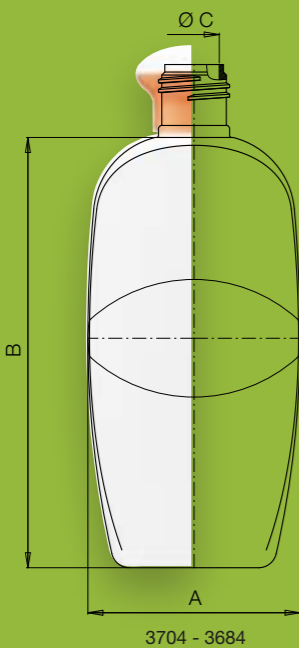

1490; 1491;
1805/1
Fitted plug



1490/1; 1491/1;
1805
Built-in seal

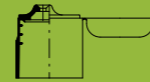

1834; 7713;
7714



1494; 1496
Fitted plug



1494/1; 1496/1
Built-in seal



1801; 1803
Built-in seal



7379; 7380
Disc-Top

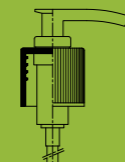

7456
Dispenser



7726
Pump

3704 - 3684

FLASCHE BOTTLE FLACON

VERSCHLUSS CLOSURE CAPSULE

Article no.	Capacity	Material	Weight	Neck finish	A	B	ø C	Article no.
FPS 3704	75 ml	HDPE	10 g	20/415	48 mm	97 mm	14 mm	1803, 1805, 1805/1, 7726
FPS 3681	200 ml	HDPE	20 g	24/415	66 mm	133 mm	17 mm	1491, 1491/1, 1496, 1496/1, 1801, 1834, 7379, 7713
FPS 3682	250 ml	HDPE	23 g	24/415	71 mm	143 mm	17 mm	1491, 1491/1, 1496, 1496/1, 1801, 1834, 7379, 7713
FPS 3683	300 ml	HDPE	26 g	24/415	75 mm	152 mm	17 mm	1491, 1491/1, 1496, 1496/1, 1801, 1834, 7379, 7713
FPS 3684	500 ml	HDPE	36 g	28/415	88 mm	178 mm	21 mm	1490, 1490/1, 1494, 1494/1, 7380, 7456, 7714



FPS 3704
+ 7726



FPS 3681
+ 1801



FPS 3682
+ 1491



FPS 3683
+ 7713



FPS 3684
+ 1494

CARISMA



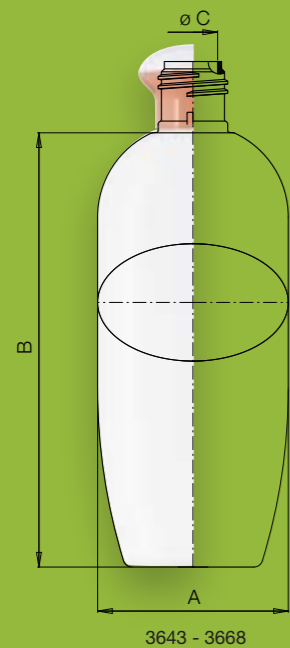

1490; 1491
Fitted plug



1490/1; 1491/1;
7371
Built-in seal

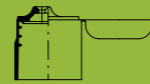

1834; 7713;
7714



1494; 1496
Fitted plug



1494/1; 1496/1
Built-in seal



1801
Built-in seal



7379; 7380
Disc-Top

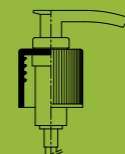

7456
Dispenser

FLASCHE BOTTLE FLACON

VERSCHLUSS CLOSURE CAPSULE

Article no.	Capacity	Material	Weight	Neck finish	A	B	ø C	Article no.
FPS 3643	150 ml	HDPE, PP	16 g	24/415	54 mm	118 mm	17 mm	1491, 1491/1, 1496, 1496/1, 1801, 1834, 7379, 7713
FPS 3625	200 ml	HDPE, PP	20 g	24/415	58 mm	134 mm	17 mm	1491, 1491/1, 1496, 1496/1, 1801, 1834, 7379, 7713
FPS 3626	250 ml	HDPE, PP	23 g	24/415	65 mm	148 mm	17 mm	1491, 1491/1, 1496, 1496/1, 1801, 1834, 7379, 7713
FPS 3627	300 ml	HDPE, PP	26 g	24/415	70 mm	159 mm	17 mm	1491, 1491/1, 1496, 1496/1, 1801, 1834, 7379, 7713
FPS 3644	400 ml	HDPE, PP	32 g	28/415	75 mm	169 mm	21 mm	1490, 1490/1, 1494, 1494/1, 7380, 7456, 7714
FPS 3645	500 ml	HDPE, PP	36 g	28/415	82 mm	183 mm	21 mm	1490, 1490/1, 1494, 1494/1, 7380, 7456, 7714
FPS 3668	1000 ml	HDPE	48 g	REBHAN	96 mm	232 mm	25 mm	7371



FPS 3643
+ 1491



FPS 3625
+ 1496



FPS 3626
+ 7379



FPS 3627
+ 7713



FPS 3644
+ 7456



FPS 3645
+ 1494

OPERA



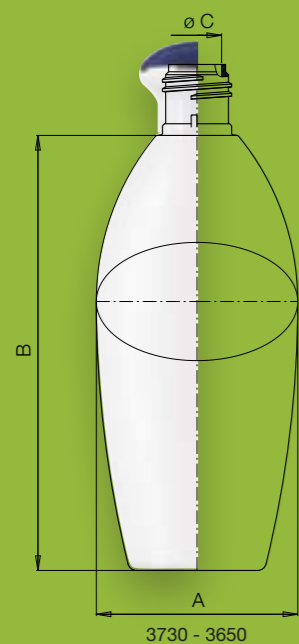

1490; 1491;
1805/1
Fitted plug



1490/1; 1491/1;
1805
Built-in seal

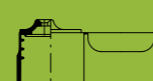

1834; 7713;
7714



1494; 1496
Fitted plug



1494/1; 1496/1
Built-in seal



1801; 1803
Built-in seal



7379; 7380
Disc-Top

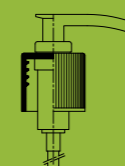

7456; 7472
Dispenser



7726
Pump



7453
Pump

FLASCHE BOTTLE FLACON

VERSCHLUSS CLOSURE CAPSULE

Article no.	Capacity	Material	Weight	Neck finish	A	B	ø C	Article no.
FPS 3730	50 ml	HDPE	8 g	20/415	41 mm	86 mm	14 mm	1803, 1805, 1805/1, 7726
FPS 3730/1	50 ml	HDPE	8 g	20/410	41 mm	86 mm	14 mm	7453
FPS 3911	100 ml	HDPE, PP	13 g	24/415	49 mm	105 mm	17 mm	1491, 1491/1, 1496, 1496/1, 1801, 1834, 7379, 7713
FPS 3648	150 ml	HDPE, PP	16 g	24/415	56 mm	121 mm	17 mm	1491, 1491/1, 1496, 1496/1, 1801, 1834, 7379, 7713
FPS 3628	200 ml	HDPE, PP	21 g	24/415	62 mm	134 mm	17 mm	1491, 1491/1, 1496, 1496/1, 1801, 1834, 7379, 7713
FPS 3628/1	200 ml	HDPE, PP	20 g	24/415	62 mm	134 mm	21 mm	7472
FPS 3629	250 ml	HDPE, PP	23 g	24/415	69 mm	149 mm	17 mm	1491, 1491/1, 1496, 1496/1, 1801, 1834, 7379, 7713
FPS 3630	300 ml	HDPE, PP	26 g	24/415	75 mm	161 mm	17 mm	1491, 1491/1, 1496, 1496/1, 1801, 1834, 7379, 7713
FPS 3649	400 ml	HDPE, PP	31 g	28/415	82 mm	170 mm	21 mm	1490, 1490/1, 1494, 1494/1, 7380, 7456, 7714
FPS 3650	500 ml	HDPE, PP	36 g	28/415	88 mm	184 mm	21 mm	1490, 1490/1, 1494, 1494/1, 7380, 7456, 7714



FPS 3730
+ 7726



FPS 3628
+ 1496



FPS 3629
+ 7379



FPS 3630
+ 7713



FPS 3649
+ 7456



FPS 3650
+ 1490

ENEZIA



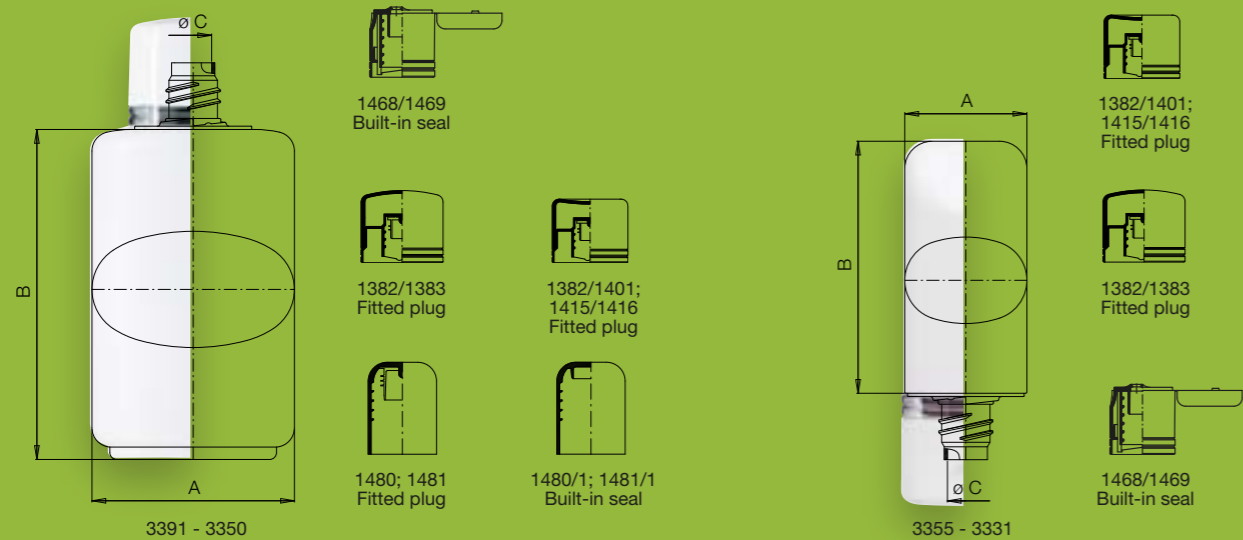

FLASCHE BOTTLE FLACON

Article no.	Capacity	Material	Weight	Neck finish	A	B	ø C
FPS 3391	50 ml	HDPE	8 g	REBHAN	45 mm	73 mm	10 mm
FPS 3391/1	50 ml	HDPE	8 g	REBHAN	45 mm	73 mm	13 mm
FPS 3395	100 ml	HDPE	14 g	REBHAN	56 mm	90 mm	10 mm
FPS 3395/1	100 ml	HDPE	14 g	REBHAN	56 mm	90 mm	13 mm
FPS 3281	150 ml	HDPE	18 g	REBHAN	63 mm	101 mm	13 mm
FPS 3282	200 ml	HDPE	20 g	REBHAN	68 mm	111 mm	13 mm
FPS 3283	250 ml	HDPE	22 g	REBHAN	74 mm	120 mm	13 mm
FPS 3284	300 ml	HDPE	28 g	REBHAN	78 mm	128 mm	13 mm
FPS 3350	500 ml	HDPE	40 g	REBHAN	90 mm	162 mm	13 mm

VERSCHLUSS CLOSURE CAPSULE

Article no.	Article no.
1415/1416	1415/1416
1480, 1480/1	1415/1416
1415/1416	1481, 1481/1
1382/1383, 1382/1401, 1468/1469	1382/1383, 1382/1401, 1468/1469
1382/1383, 1382/1401, 1468/1469	1382/1383, 1382/1401, 1468/1469
1382/1383, 1382/1401, 1468/1469	1382/1383, 1382/1401, 1468/1469
1382/1383, 1382/1401, 1468/1469	1382/1383, 1382/1401, 1468/1469

TUBENFLASCHE TOTTLE FLACON TUBE

Article no.	Capacity	Material	Weight	Neck finish	A	B	ø C
FPS 3355	30 ml	HD-/LDPE	7 g	REBHAN	37 mm	74 mm	10 mm
FPS 3356	40 ml	HD-/LDPE	9 g	REBHAN	37 mm	92 mm	10 mm
FPS 3357	50 ml	HD-/LDPE	10 g	REBHAN	37 mm	110 mm	10 mm
FPS 3309	75 ml	HD-/LDPE	11 g	REBHAN	45 mm	92 mm	13 mm
FPS 3308	100 ml	HD-/LDPE	13 g	REBHAN	45 mm	119 mm	13 mm
FPS 3331	200 ml	HD-/LDPE	20 g	REBHAN	53 mm	148 mm	13 mm

VERSCHLUSS CLOSURE CAPSULE

Article no.	Article no.
1415/1416	1415/1416
1415/1416	1415/1416
1415/1416	1415/1416
1382/1401, 1468/1469, 1382/1383	1382/1401, 1468/1469, 1382/1383
1382/1401, 1468/1469, 1382/1383	1382/1401, 1468/1469, 1382/1383
1382/1401, 1468/1469, 1382/1383	1382/1401, 1468/1469, 1382/1383



COLOR



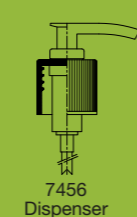
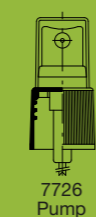
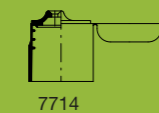
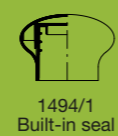
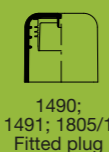
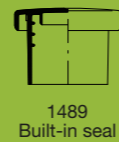
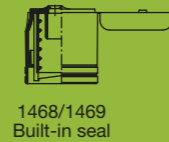
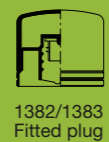
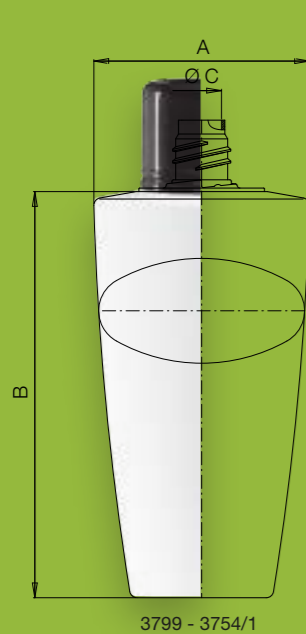

3799 - 3754/1

FLASCHE BOTTLE FLACON

VERSCHLUSS CLOSURE CAPSULE

Article no.	Capacity	Material	Weight	Neck finish	A	B	ø C	Article no.
FPS 3799	100 ml	HDPE	16 g	REBHAN	59 mm	111 mm	10 mm	1415/1416
FPS 3799/1	100 ml	HDPE	16 g	20/415	59 mm	111 mm	14 mm	1803, 1805, 1805/1, 7726
FPS 3752	200 ml	HDPE	22 g	REBHAN	73 mm	138 mm	13 mm	1382/1383, 1382/1401, 1468/1469
FPS 3752/1	200 ml	HDPE	22 g	28/415	73 mm	138 mm	21 mm	1489, 1489/1, 1490, 1490/1, 1494, 1494/1, 7380, 7456, 7714
FPS 3753	250 ml	HDPE	25 g	REBHAN	78 mm	148 mm	13 mm	1382/1383, 1382/1401, 1468/1469
FPS 3753/1	250 ml	HDPE	25 g	28/415	78 mm	148 mm	21 mm	1489, 1489/1, 1490, 1490/1, 1494, 1494/1, 7380, 7456, 7714
FPS 3754	300 ml	HDPE	28 g	REBHAN	82 mm	158 mm	13 mm	1382/1383, 1382/1401, 1468/1469
FPS 3754/1	300 ml	HDPE	28 g	28/415	82 mm	158 mm	21 mm	1490, 1490/1, 1494, 1494/1, 7380, 7456, 7714



EVOLUTION



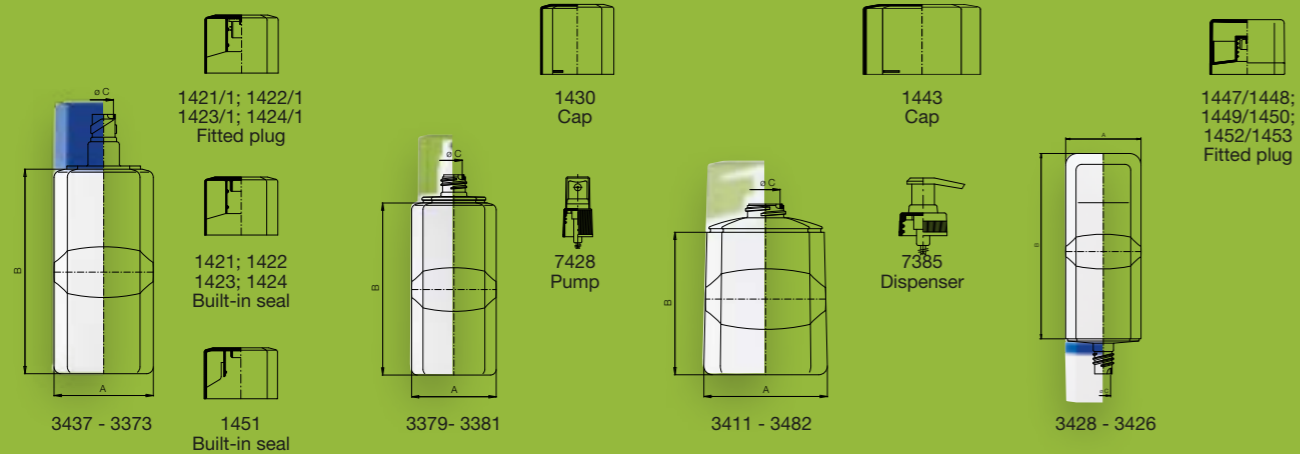

FLASCHE BOTTLE FLACON

Article no.	Capacity	Material	Weight	Neck finish	A	B	ø C	Article no.
FPS 3437	30 ml	HDPE	6 g	REBHAN	38 mm	67 mm	10 mm	1451
FPS 3366	100 ml	HDPE	13 g	REBHAN	52 mm	107 mm	10 mm	1421, 1421/1
FPS 3379	100 ml	HDPE	15 g	GL 18	52 mm	105 mm	11 mm	1430, 7428
FPS 3367	125 ml	HDPE	15 g	REBHAN	56 mm	115 mm	10 mm	1421, 1421/1
FPS 3380	125 ml	HDPE	18 g	GL 18	56 mm	113 mm	11 mm	1430, 7428
FPS 3368	150 ml	HDPE	17 g	REBHAN	58 mm	120 mm	13 mm	1422, 1422/1
FPS 3440	150 ml	PETG	18 g	REBHAN	58 mm	120 mm	13 mm	1422, 1422/1
FPS 3381	150 ml	HDPE	20 g	GL 18	58 mm	119 mm	11 mm	1430, 7428
FPS 3369	200 ml	HDPE	20 g	REBHAN	64 mm	131 mm	13 mm	1422, 1422/1
FPS 3370	250 ml	HDPE	25 g	REBHAN	69 mm	141 mm	13 mm	1423, 1423/1
FPS 3411	250 ml	HDPE	25 g	28/400	85 mm	99 mm	10 mm	1443, 7385
FPS 3371	300 ml	HDPE	27 g	REBHAN	73 mm	150 mm	13 mm	1423, 1423/1
FPS 3412	300 ml	HDPE	28 g	28/400	86 mm	116 mm	10 mm	1443, 7385
FPS 3372	400 ml	HDPE	34 g	REBHAN	80 mm	165 mm	17 mm	1424, 1424/1
FPS 3373	500 ml	HDPE	43 g	REBHAN	86 mm	179 mm	17 mm	1424, 1424/1
FPS 3482	500 ml	HDPE	50 g	28/400	98 mm	143 mm	20 mm	1443, 7385

TUBENFLASCHE TOTTLE FLACON TUBE

Article no.	Capacity	Material	Weight	Neck finish	A	B	ø C	Article no.
FPS 3428	30 ml	HD-/LDPE	7 g	REBHAN	40 mm	74 mm	10 mm	1452/1453
FPS 3429	40 ml	HD-/LDPE	9 g	REBHAN	40 mm	93 mm	10 mm	1452/1453
FPS 3430	50 ml	HD-/LDPE	10 g	REBHAN	40 mm	113 mm	10 mm	1452/1453
FPS 3431	75 ml	HD-/LDPE	11 g	REBHAN	53 mm	100 mm	10 mm	1449/1450
FPS 3432	100 ml	HD-/LDPE	13 g	REBHAN	53 mm	128 mm	10 mm	1449/1450
FPS 3433	125 ml	HD-/LDPE	15 g	REBHAN	64 mm	105 mm	13 mm	1447/1448
FPS 3426	150 ml	HD-/LDPE	21 g	REBHAN	64 mm	123 mm	13 mm	1447/1448



KARAT



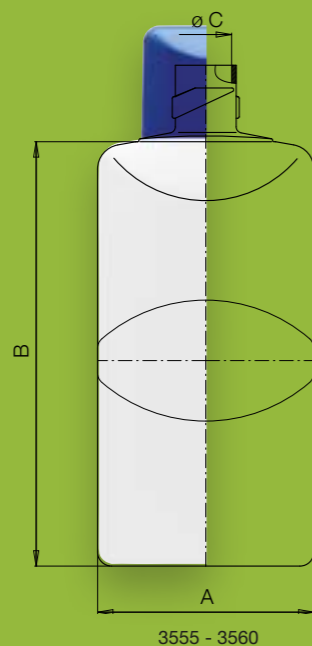

1484/1485
Fitted plug

FLASCHE BOTTLE FLACON

VERSCHLUSS CLOSURE CAPSULE

Article no.	Capacity	Material	Weight	Neck finish	A	B	ø C	Article no.
FPS 3555	150 ml	HDPE	17 g	REBHAN	60 mm	118 mm	17 mm	1484/1485
FPS 3556	200 ml	HDPE	20 g	REBHAN	66 mm	129 mm	17 mm	1484/1485
FPS 3557	250 ml	HDPE	24 g	REBHAN	70 mm	138 mm	17 mm	1484/1485
FPS 3558	300 ml	HDPE	27 g	REBHAN	75 mm	147 mm	17 mm	1484/1485
FPS 3559	400 ml	HDPE	33 g	REBHAN	82 mm	160 mm	17 mm	1484/1485
FPS 3560	500 ml	HDPE	38 g	REBHAN	88 mm	172 mm	17 mm	1484/1485



FPS 3555



FPS 3556



FPS 3557



FPS 3558



FPS 3559



FPS 3560

CONTURA



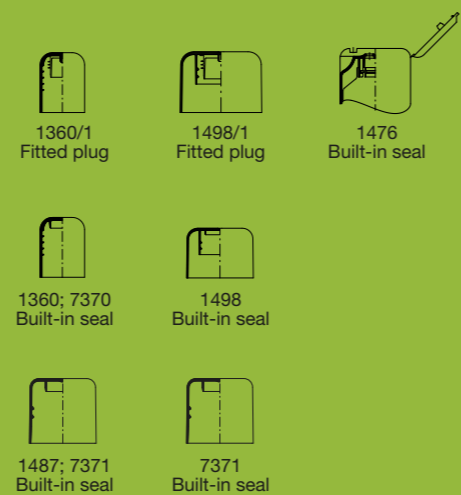
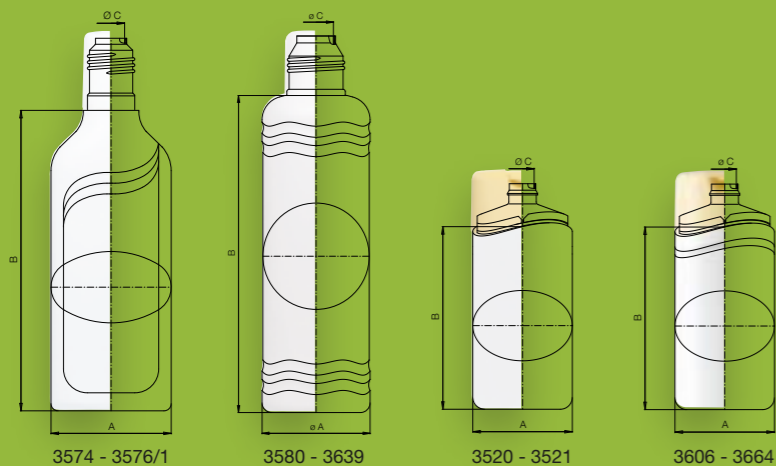

FLASCHE BOTTLE FLACON

VERSCHLUSS CLOSURE CAPSULE

Article no.	Capacity	Material	Weight	Neck finish	A	B	ø C	Article no.
FPS 3606	200 ml	HDPE	18 g	REBHAN	67 mm	96 mm	15 mm	1476
FPS 3522	250 ml	HDPE	20 g	REBHAN	67 mm	122 mm	15 mm	1476
FPS 3574	250 ml	HDPE	20 g	REBHAN	72 mm	144 mm	17 mm	1360, 1360/1
FPS 3520	250 ml	HDPE	20 g	REBHAN	67 mm	118 mm	15 mm	1476
FPS 3521	300 ml	HDPE	24 g	REBHAN	67 mm	141 mm	15 mm	1476
FPS 3523	300 ml	HDPE	24 g	REBHAN	67 mm	147 mm	15 mm	1476
FPS 3664	300 ml	PET	24 g	REBHAN	67 mm	139 mm	15 mm	1476
FPS 3575	500 ml	HDPE	32 g	REBHAN	80 mm	200 mm	18 mm	7370
FPS 3576	1000 ml	HDPE	47 g	REBHAN	95 mm	232 mm	25 mm	1487
FPS 3576/1	1000 ml	HDPE	45 g	REBHAN	95 mm	232 mm	25 mm	7371
FPS 3580	1000 ml	HDPE	42 g	REBHAN	78 mm	229 mm	25 mm	7371
FPS 3639	1000 ml	PET	45 g	REBHAN	78 mm	233 mm	21 mm	1498, 1498/1

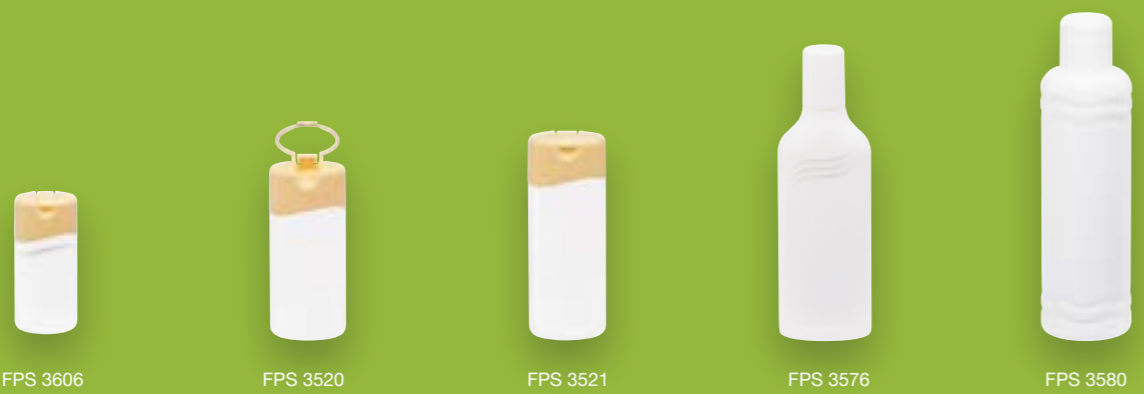

SWING



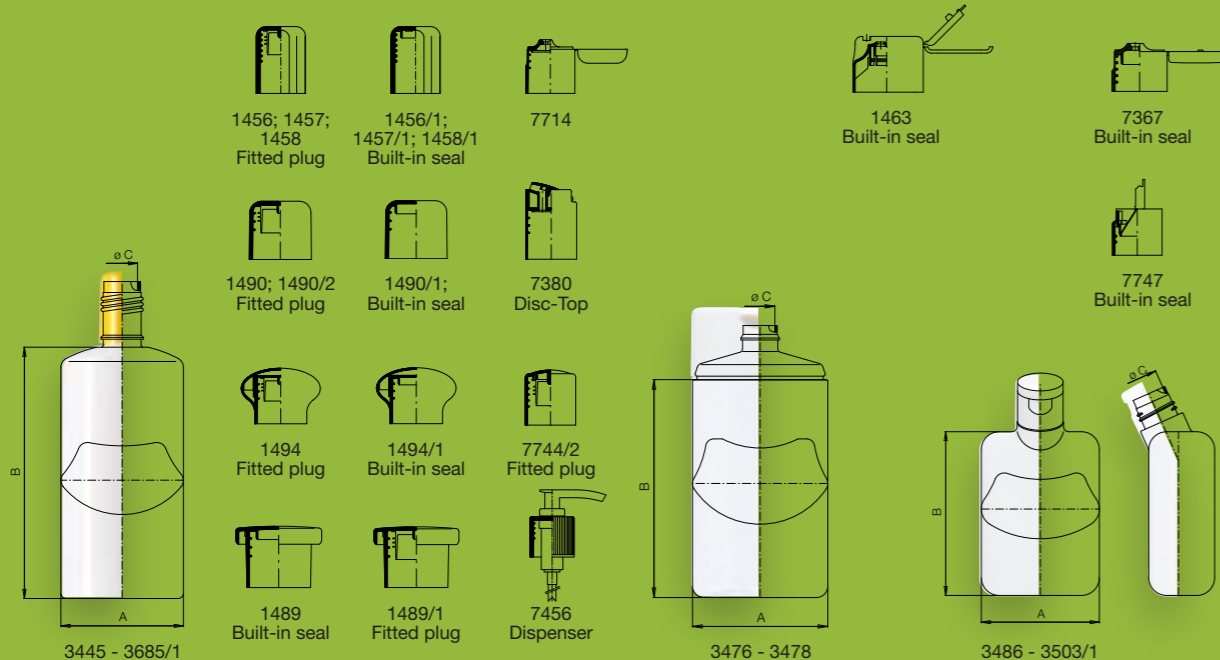

FLASCHE BOTTLE FLACON

VERSCHLUSS CLOSURE CAPSULE

Article no.	Capacity	Material	Weight	Neck finish	A	B	ø C	Article no.
FPS 3445	100 ml	PET-EX	12 g	REBHAN	50 mm	102 mm	14 mm	1456, 1456/1
FPS 3446	125 ml	PET-EX	15 g	REBHAN	54 mm	111 mm	14 mm	1456, 1456/1
FPS 3447	150 ml	PET-EX	18 g	REBHAN	57 mm	117 mm	14 mm	1456, 1456/1
FPS 3486	150 ml	PETG	18 g	REBHAN	66 mm	92 mm	17 mm	7367
FPS 3503/1	150 ml	HDPE	15 g	REBHAN	66 mm	92 mm	19 mm	7747
FPS 3448	200 ml	PET-EX	23 g	REBHAN	63 mm	128 mm	17 mm	1457, 1457/1
FPS 3533	200 ml	HDPE	20 g	REBHAN	63 mm	128 mm	17 mm	1457, 1457/1
FPS 3476	200 ml	HDPE	20 g	REBHAN	70 mm	89 mm	15 mm	1463
FPS 3477	250 ml	HDPE	23 g	REBHAN	70 mm	113 mm	15 mm	1463
FPS 3674	250 ml	PET	27 g	REBHAN	70 mm	113 mm	15 mm	1463
FPS 3449	250 ml	PET-EX	26 g	REBHAN	67 mm	138 mm	17 mm	1457, 1457/1
FPS 3450	300 ml	PET-EX	29 g	REBHAN	72 mm	147 mm	17 mm	1457, 1457/1
FPS 3478	300 ml	HDPE	27 g	REBHAN	70 mm	137 mm	15 mm	1463
FPS 3451	400 ml	PET-EX	37 g	REBHAN	78 mm	160 mm	17 mm	1458, 1458/1
FPS 3452	500 ml	PET-EX	42 g	REBHAN	84 mm	173 mm	21 mm	1458, 1458/1
FPS 3685	500 ml	PET	30 g	28/415	84 mm	173 mm	21 mm	1489, 1489/1, 1490, 1490/1, 1490/2 (PET), 1494, 1494/1, 7380, 7456, 7714, 7744/2 (PET)
FPS 3685/1	500 ml	PET	30 g	REBHAN	84 mm	173 mm	21mm	1458, 1458/1



FPS 3447



FPS 3449



FPS 3452



FPS 3478



FPS 3476

TRAPEZ



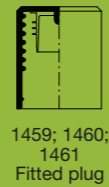
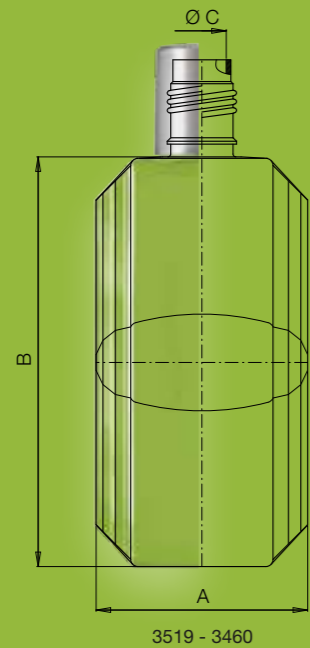

1459; 1460;
1461
Fitted plug



1459/1; 1460/1;
1461/1; 1477
Built-in seal



7675; 7378
Built-in seal

FLASCHE BOTTLE FLACON

VERSCHLUSS CLOSURE CAPSULE

Article no.	Capacity	Material	Weight	Neck finish	A	B	ø C	Article no.
FPS 3519	12 ml	PET	4 g	REBHAN	29 mm	46 mm	7 mm	1477
FPS 3453	100 ml	PET	21 g	REBHAN	60 mm	89 mm	14 mm	1459, 1459/1
FPS 3454	125 ml	PET	23 g	REBHAN	65 mm	96 mm	14 mm	1459, 1459/1
FPS 3455	150 ml	PET	26 g	REBHAN	69 mm	102 mm	14 mm	1459, 1459/1
FPS 3456	200 ml	PET-EX	24 g	REBHAN	68 mm	132 mm	17 mm	1460, 1460/1
FPS 3457	250 ml	PET-EX	27 g	REBHAN	73 mm	141 mm	17 mm	1460, 1460/1
FPS 3457/1	250 ml	PET-EX	27 g	REBHAN	73 mm	141 mm	19 mm	7378
FPS 3458	300 ml	PET-EX	31 g	REBHAN	77 mm	150 mm	21 mm	1461, 1461/1
FPS 3458/1	300 ml	PET-EX	31 g	REBHAN	77 mm	150 mm	21 mm	7675
FPS 3459	400 ml	PET-EX	39 g	REBHAN	85 mm	165 mm	21 mm	1461, 1461/1
FPS 3460	500 ml	PET-EX	45 g	REBHAN	92 mm	178 mm	21 mm	1461, 1461/1



FPS 3519



FPS 3453



FPS 3455



FPS 3457

SAPHIR



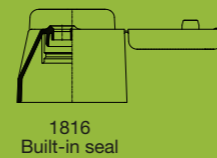
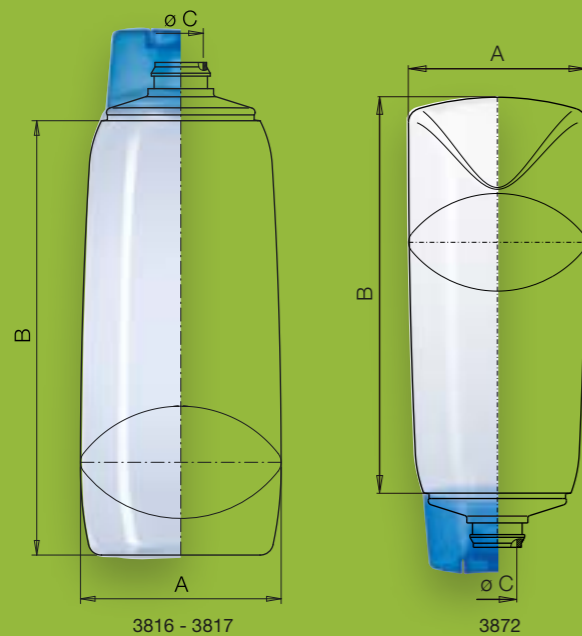

FLASCHE BOTTLE FLACON

Article no.	Capacity	Material	Weight	Neck finish	A	B	ø C
FPS 3816	250 ml	PET	22 g	REBHAN	69 mm	149 mm	15 mm
FPS 3817	300 ml	PET	24 g	REBHAN	72 mm	159 mm	15 mm

VERSCHLUSS CLOSURE CAPSULE

Article no.
1816
1816

TUBENFLASCHE TOTTLE FLACON TUBE

Article no.	Capacity	Material	Weight	Neck finish	A	B	ø C
FPS 3872	200 ml	PP	20 g	REBHAN	66 mm	146 mm	15 mm

VERSCHLUSS CLOSURE CAPSULE

Article no.
1816



FPS 3816



FPS 3817



FPS 3872

POLARIS



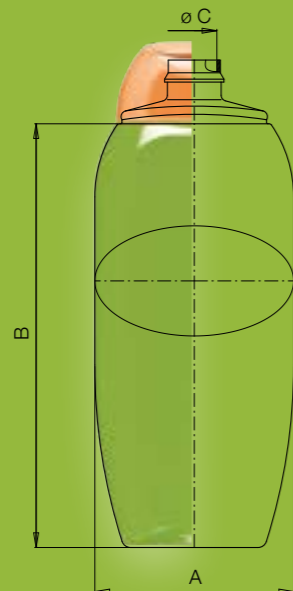

3619 - 3667



1493 (bright);
1493/1 (matt)
Built-in seal

FLASCHE BOTTLE FLACON

VERSCHLUSS CLOSURE CAPSULE

Article no.	Capacity	Material	Weight	Neck finish	A	B	ø C	Article no.
FPS 3619	200 ml	PET	20 g	REBHAN	63 mm	134 mm	15 mm	1493, 1493/1
FPS 3620	250 ml	PET	22 g	REBHAN	68 mm	144 mm	15 mm	1493, 1493/1
FPS 3621	300 ml	PET	24 g	REBHAN	71 mm	153 mm	15 mm	1493, 1493/1
FPS 3667	300 ml	HDPE	23 g	REBHAN	72 mm	155 mm	15 mm	1493, 1493/1



FPS 3619



FPS 3620



FPS 3621



FPS 3667

PALAZZO



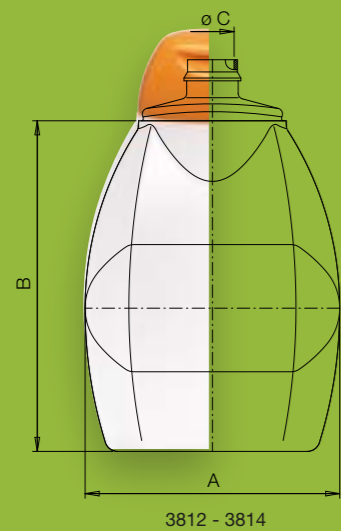

3812 - 3814

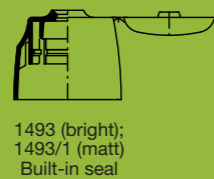

1493 (bright);
1493/1 (matt)
Built-in seal

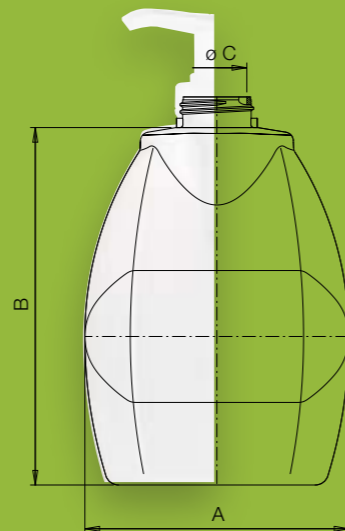

3814/1

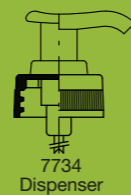

7734
Dispenser

FLASCHE BOTTLE FLACON

VERSCHLUSS CLOSURE CAPSULE

Article no.	Capacity	Material	Weight	Neck finish	A	B	ø C	Article no.
FPS 3812	200 ml	PP	19 g	REBHAN	80 mm	98 mm	15 mm	1493, 1493/1
FPS 3813	250 ml	PP	20 g	REBHAN	85 mm	108 mm	15 mm	1493, 1493/1
FPS 3814	300 ml	PP	22 g	REBHAN	90 mm	118 mm	15 mm	1493, 1493/1
FPS 3814/1	300 ml	HDPE	28 g	REBHAN	90 mm	123 mm	20 mm	7734



FPS 3812



FPS 3813



FPS 3814/1

AVANTI



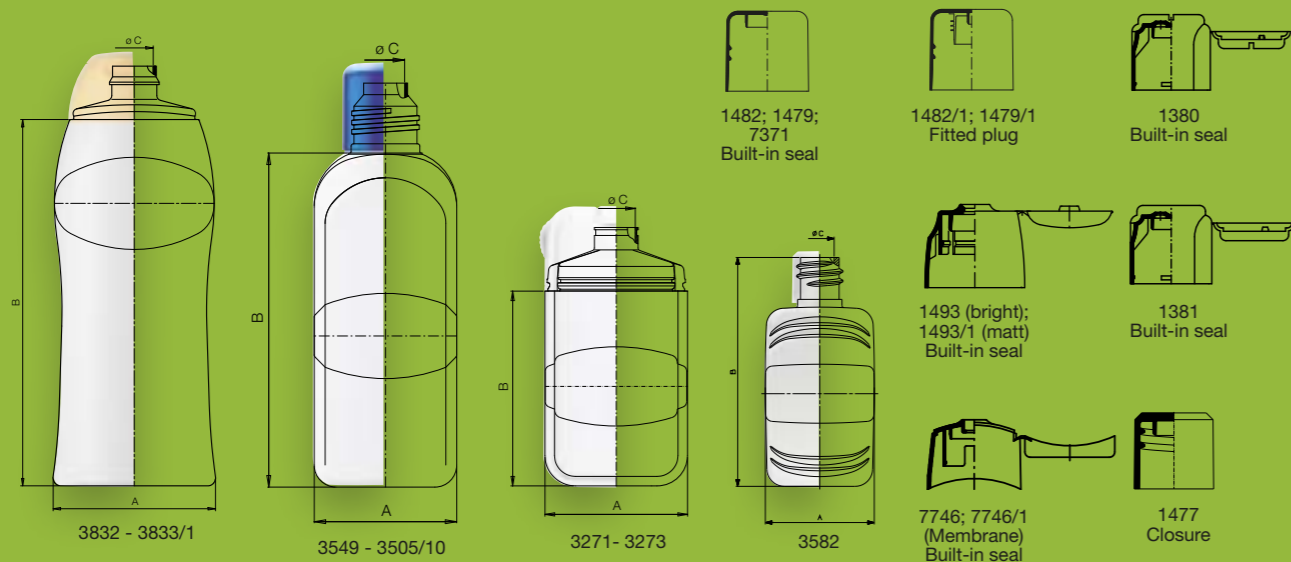

FLASCHE BOTTLE FLACON

VERSCHLUSS CLOSURE CAPSULE

Article no.	Capacity	Material	Weight	Neck finish	A	B	ø C	Article no.
FPS 3582	10 ml	PET	3,5 g	Rebhan	28 mm	46 mm	7 mm	1477
FPS 3549	150 ml	HDPE	14 g	REBHAN	53 mm	118 mm	17 mm	1482, 1482/1
FPS 3542	200 ml	HDPE	16 g	REBHAN	58 mm	135 mm	17 mm	1482, 1482/1
FPS 3271	200 ml	HDPE	16 g	REBHAN	75 mm	83 mm	20 mm	1380, 1381
FPS 3832	250 ml	HDPE	22 g	REBHAN	66 mm	149 mm	15 mm	1493, 1493/1
FPS 3832/1	250 ml	HDPE	22 g	REBHAN	66 mm	149 mm	18 mm	7746, 7746/1 MEMBRAN MEMBRANE ANSE
FPS 3543	250 ml	HDPE	20 g	REBHAN	63 mm	145 mm	17 mm	1482, 1482/1
FPS 3272	250 ml	HDPE	19 g	REBHAN	75 mm	103 mm	20 mm	1380, 1381
FPS 3544	300 ml	HDPE	24 g	REBHAN	67 mm	155 mm	17 mm	1482, 1482/1
FPS 3273	300 ml	HDPE	23 g	REBHAN	75 mm	123 mm	20 mm	1380, 1381
FPS 3833	400 ml	HDPE	31 g	REBHAN	77 mm	188 mm	15 mm	1493, 1493/1
FPS 3833/1	400 ml	HDPE	31 g	REBHAN	77 mm	188 mm	18 mm	7746, 7746/1 MEMBRAN MEMBRANE ANSE
FPS 3553	400 ml	HDPE	28 g	REBHAN	73 mm	170 mm	22 mm	1479, 1479/1
FPS 3532	500 ml	HDPE	32 g	REBHAN	79 mm	183 mm	22 mm	1479, 1479/1
FPS 3561	750 ml	HDPE	43 g	REBHAN	85 mm	241 mm	25 mm	7371
FPS 3505	1000 ml	HDPE	55 g	REBHAN	94 mm	238 mm	25 mm	7371



BATH & SHOWER



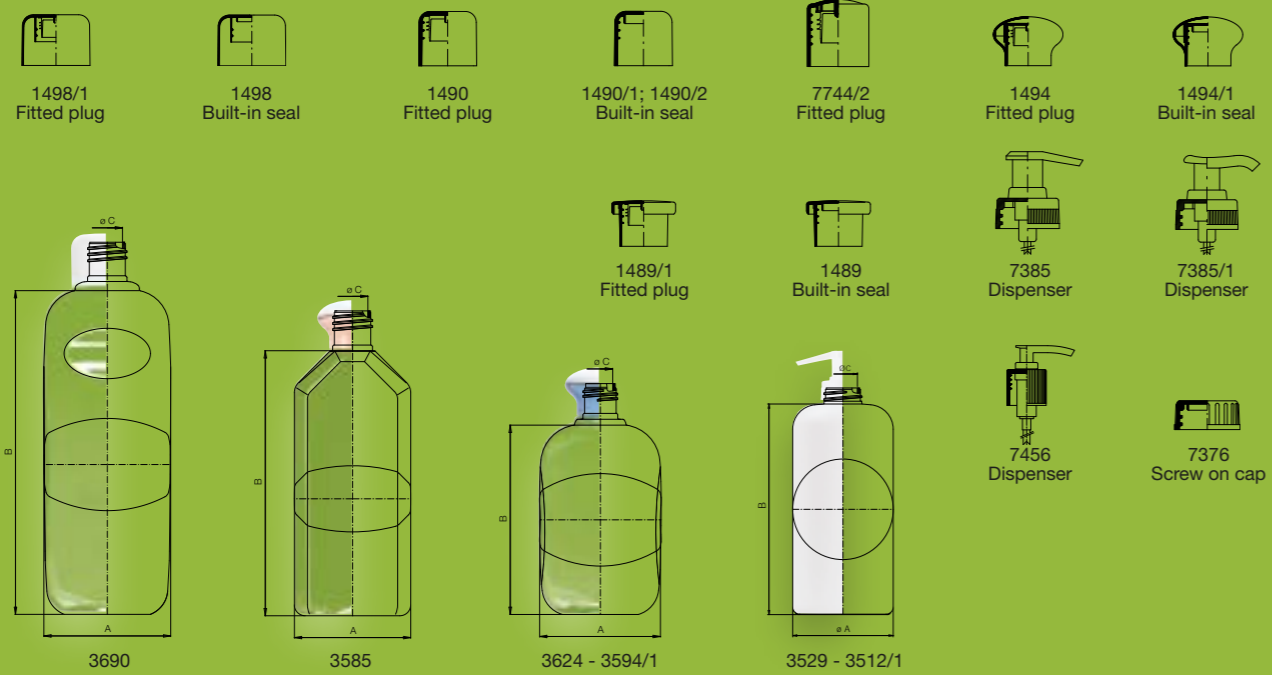

FLASCHE BOTTLE FLACON VERSCHLUSS CLOSURE CAPSULE

Article no.	Capacity	Material	Weight	Neck finish	A	B	ø C	Article no.
FPS 3624	300 ml	PET	22 g	28/400	71 mm	114 mm	21 mm	7385, 7385/1
FPS 3529	300 ml	HDPE	28 g	28/400	68 mm	101 mm	20 mm	7376, 7385, 7385/1
FPS 3585	500 ml	PET	31 g	28/415	80 mm	182 mm	21 mm	1489, 1489/1, 1490, 1490/1, 1490/2 (PET), 1494, 1494/1, 7744/2 (PET), 7456
FPS 3594	500 ml	PET	29 g	28/400	83 mm	133 mm	21 mm	7385, 7385/1
FPS 3594/1	500 ml	PET-EX	36 g	28/415	83 mm	133 mm	21 mm	1489, 1489/1, 1490, 1490/1, 1490/2 (PET), 1494, 1494/1, 7744/2 (PET)
FPS 3512/1	500 ml	HDPE	27 g	28/400	72 mm	151 mm	21 mm	7385, 7385/1
FPS 3690	1000 ml	PET	45 g	28/415	88 mm	225 mm	21 mm	1489, 1489/1, 1490, 1490/1, 1498, 1498/1, 7744/2 (PET)



BATH & SHOWER II

